

RESTORING RARE NATIVE HABITATS IN THE WILLAMETTE VALLEY

*A Landowner's Guide for Restoring Oak Woodlands,
Wetlands, Prairies, and Bottomland Hardwood and
Riparian Forests.*



By Bruce H. Campbell





**We gratefully acknowledge the support of the
U.S. Fish and Wildlife Service,
the Oregon Department of Fish and Wildlife,
and the National Fish and Wildlife Foundation
in the production of this publication**

RESTORING RARE NATIVE HABITATS IN THE WILLAMETTE VALLEY

*A Landowner's Guide for Restoring Oak Woodlands,
Wetlands, Prairies, and Bottomland Hardwood
and Riparian Forests*

By Bruce H. Campbell

DEFENDERS OF WILDLIFE
WEST LINN, OREGON • WASHINGTON D.C.

AUTHOR

Bruce H. Campbell

EDITOR

Bruce Taylor, Defenders of Wildlife

PRODUCTION

Kassandra Kelly, Defenders of Wildlife

IMAGES

Photographs provided by Rick Barney, Bruce H. Campbell, Jenne Reische, Bruce Taylor. Figures and sketches provided by the California Department of Fish and Game; the U.S.D.A. Natural Resource Conservation Service; *Restoring Streams in Cities* by Ann L. Riley, Island Press; Washington State University; and the Washington State Department of Ecology.

DEFENDERS OF WILDLIFE

West Coast Office

1880 Willamette Falls Drive

Suite 200

West Linn, Oregon 97068

503.697.3222

<http://www.biodiversitypartners.org>

National Headquarters

1130 17th Street NW

Washington D.C. 20036

202.682.9400

<http://www.defenders.org>

Additional copies of this report may be ordered from
the Oregon Department of Fish and Wildlife website at

<http://www.dfw.state.or.us/>

or the Biodiversity Partnership website at

<http://www.biodiversitypartners.org>



Defenders of Wildlife, West Linn, Oregon 97068

Defenders of Wildlife, Washington D.C. 20036

© 2004 by Bruce H. Campbell

All rights reserved. Abstracting is permitted with credit to the source.

Acknowledgments and Dedication: _____

Many people provided assistance, support, and encouragement during the development of this guide. Sara Vickerman, Director of the West Coast Office of Defenders of Wildlife, deserves special recognition for understanding and championing management practice guidelines for landowners that benefit our rare habitats, fish, and wildlife. Sara's patience and encouragement made this guide possible. Thanks also to Bruce Taylor, Oregon Habitat Joint Venture and Defenders of Wildlife, and Kassandra Kelly, Defenders of Wildlife, for their technical review, editing, and production support that turned a manuscript into a publishable document. Without their hard work and expertise, this project would not have succeeded. Acknowledgment and a special thank you goes to Ed Alverson, Alan Branscom, Dean Apostol, and John Miller for their reviews and comments. Their thoughtful insights strengthened this guide. I thank individuals with the Oregon Department of Fish and Wildlife for their encouragement and assistance with obtaining the grant that helped Defenders of Wildlife publish this guide. Lastly, I acknowledge my wife, Linda Campbell, who tolerated my many evenings in the "dungeon" in front of the computer.

I dedicate this guidebook to those who have recognized the important role that private landowners play in fish and wildlife habitat stewardship and who have put countless hours into developing and maintaining cooperative and incentive programs. Without their vision and dedication the people of Oregon would be poorer.

Contents:

PREFACE	1	Installation of Small Dikes, Levees, and Embankments:	22
1. INTRODUCTION	3	<i>Straw Wattles and Excelsior Logs, Straw Bale Dams, Notched Log; Dams, Rock Check Dams, Wooden Check Dams, Dirt Berm Dams</i>	
2. OAK WOODLANDS AND SAVANNAS	5	Breaching Water Containing and Water Control Structures:	27
Enhancing Existing Oregon White Oak Stands	5	<i>Water Control Structures; Large Dirt Berms; Permits</i>	
Conifer Encroachment:	5	Control of Unwanted Vegetation:	28
<i>Prescribed Burning; Tree Removal and Snag Creation</i>		<i>Creeping Buttercup; Reed Canarygrass; Purple Loosestrife; Japanese Knotweed; Blackberries; Scotch (Scott's) Broom</i>	
Over-crowding:	6	Other Restoration Considerations	31
<i>Thinning</i>		Revegetation	32
Restoring Historic Oregon White Oak Stands	7	Plant Species Selection: Structure	32
Pre-planting Preparation:	7	Plant Species Selection: Species	33
<i>Site Selection; Seeds or Seedlings?</i>		Types of Planting	33
Germinating and Planting Acorns:	8	<i>Seeding, Seed Collection, Seedbed Preparation and Seeding</i>	
<i>Direct Planting; Nursery Propagation; Seedling Care; Bareroot Stock; Site Preparation and Planting Seedlings; Seedling Protection; Fertilization, Irrigation, and Pruning after Planting; Tree Shelter Maintenance and Follow-up</i>		Transplanting Sprigs, Plugs, Rhizomes, and Tubers:	34
Additional Considerations for all Types of Restoration:	10	<i>Cuttings; Container-grown; Balled and Burlapped, and Bare-root Plants</i>	
<i>Disease; Ground Cover; Grazing</i>		Additional Planting Considerations	36
Control of Exotic Invasives:	11	Fertilizer and Other Soil Amendments	36
<i>Blackberries, Scotch (Scott's) Broom, False Brome</i>		Additional Considerations for all Types of Restoration:	37
		<i>Grazing and Browsing Control</i>	
3. WETLANDS	16	4. BOTTOMLAND HARDWOOD AND RIPARIAN FORESTS	39
Wetland Restoration	17	Bottomland Hardwood and Riparian Forest Restoration	40
Project Planning	17	Project Planning:	40
Site Assessment:	18	<i>Project Goals; Site Characterization and Evaluation; Plant Selection; Site Preparation; Regeneration Methods; Timetable for Obtaining Stock; Funding; Permits</i>	
<i>Simple Assessment of Existing or Degraded Sites; Assessment of Disturbed Sites; Landscape Level Assessment; Project Site Level Assessment; Hydrology, Water Quality, Topography, Soils, Vegetation Associations</i>			
Funding	21		
Restoration Design and Implementation	21		
Water Supply:	22		
<i>Blocking Subsurface Drainage Systems</i>			

Contents:

Restoration Design and Implementation: <i>Water Supply; Site Preparation; Seeding or Planting? Seeding Trees and Shrubs; Seeding Forbs and Grasses; Planting Seedling Trees and Shrubs; Bare-root, Containerized, Tubed or Plug, Transplanting; Cuttings; Natural Vegetation Establishment; Seedling Protection; Maintenance</i>	43	Appendix F: Specialized Restoration Services and Supplies	97
Special Riparian Considerations: <i>Channeling and Bank Hardening, Channel Erosion and Cutting; Channel Restoration, Streambank Stabilization or Bioengineering; Livestock Grazing; Vegetation Recovery</i>	47	Appendix G: Permits Required to Collect Plants and Seeds for Revegetation and Where to Get Them	98
		Appendix H: Some Common and Special Status Wildlife Species and Habitats Where They Occur	99
5. GRASSLANDS	54	LITERATURE CITED	104
Restoring Prairies and Grasslands	55	ABOUT THE AUTHOR	112
Project Planning: <i>Project Goals; Site Characterization and Evaluation; Restoration Design; Long-term Management; Funding</i>	55	LIST OF ILLUSTRATIONS	
Restoration Implementation: <i>Site Preparation; Plowed or Tilled Seedbed Preparation; No-till Seedbed Preparation; Planting; Seeding; Seed Drills; No-till Drill; Broadcast and Interseeding; Mosaic Seeding; Cover Crops; Transplanting; Tubers and Rhizomes; Starting and Transplanting Seedlings; Collecting Seed</i>	59	Restoration goals used in this guide	4
Controlling Invasive Plants: <i>Blackberries; Brooms; Reed Canarygrass; Johnsongrass; Quackgrass; Yellow Nutsedge; Tansy Ragwort; Medusahead Rye; Biennial Thistles; Canada Thistle; Yellow Starthistle; Invasive Native Species</i>	64	Managed oak savanna at Mt. Pisgah County Park, Lane County, Oregon	5
Grazing	70	Problems to avoid during tree planting	9
Maintenance	70	Beaver pond and wetlands along Multnomah Channel, Oregon	16
APPENDICES	71	Notched log weir	24
Appendix A: Common and Scientific Names of Plants, Habitats Where They Occur, and Sources for Native Plant Stock	71	Rock weir	25
Appendix B: Seeding Rates and Depths for Some Common Native Plants	85	Brush and rock dam	25
		Post and brush dam	26
		Redwood check-dam	26
		Dirt berm reinforced with rock	27
		Target pond and diverse target pond	33
		Bottomland hardwood forest in Buford Regional Park, Oregon	39
		Cottonwood bundle	47
		Riparian zones based on moisture	48
		Blocked ditch with sticks	48
		Deadman anchor	50
		Bank shaping and planting	51
		Pond with reshaped banks	52

Contents:

LIST OF TABLES AND BOXES

Scotch broom seasonal treatment	13
Oak management decision key	14
Are there wetlands on my land?	18
Examples of wetland types	18
Selecting a check-dam type	23
Fertilizer application rates for wetland emergent plantings	37
Stream channel types	49
Approximate weight of boulders	51
Commercially available native prairie plant species	57
Key to establishing project goals	58
Herbicides and application rates	68

Preface

Bruce Taylor

Humans have been working diligently to reshape the natural features of the Willamette Valley for more than 150 years now, and with considerable success. But only recently have people begun trying to return small parts of this rich and diverse landscape to some semblance of what it was like before we got started.

These would-be restorationists haven't had much to go on. Good, healthy examples of the valley's native habitats are few and far between. Scientists still have only a limited understanding of the region's wetlands and bottomland forests, its prairies and oak savannas and woodlands, and how they function. And although some private landowners and public land managers have been working to restore wetlands and other native habitats for more than a decade now, it may be decades more before the results are fully known.

So, although many of us in the conservation community talk expansively about habitat restoration, very few have much practical experience in applying these concepts on the ground. The truth is, after more than 150 years of persistent manipulation, we have created a stubbornly non-native landscape with "natural areas" that seem more inclined to grow reed canary grass and Himalaya blackberries than sedges and snowberries.

The relative handful of individuals who have been pursuing habitat restoration in the Willamette Valley for more than a few years now have developed considerable expertise and ingenuity in addressing these challenges. But most of that expertise remains in the heads of those few pioneers. There hasn't been any single good source of information about the nuts and bolts of habitat restoration available to assist people interested in doing some of this work themselves. The problem is particularly acute for individual landowners with small holdings, who may not

have access to the kinds of technical resources available to government agencies and individuals undertaking large-scale projects.

A few years ago, wildlife biologist Bruce Campbell, who had been working with private landowners participating in the state's Wildlife Conservation and Management Program, decided to start compiling some practical guidelines for doing habitat restoration in the Willamette Valley. When Defenders of Wildlife first agreed to take on the task of turning Bruce's work into a publication, we (and Bruce) envisioned something much smaller and simpler than the present tome. But the deeper Bruce got into the subject, the larger the project became. Campbell, an employee of the Oregon Department of Fish and Wildlife, invested well over 1,000 hours of his own time in the work. We were impressed with the results, as were the experts who generously shared their comments and suggestions with Bruce and us.

In this volume you will find detailed guidance on the mechanics of re-establishing functioning examples of the Willamette Valley's rare native habitats. Much of the information is drawn from a wide variety of published sources, in some cases from other regions if no more local knowledge was available. But much of it is also the product of on-the-ground experience here in the valley, often the result of trial-and-error, a distillation of lessons learned over the years by Bruce Campbell and other practitioners of the science, art, and craft of habitat restoration. Bruce and his colleagues would be the first to tell you they are still learning; there is no simple recipe for restoring these complex systems, and this is not a cookbook. It is, however, the best set of guidance on the subject we have seen. We hope readers will put it to good use in working to create new places for nature and wildlife in the Willamette Valley.

Introduction

Nowhere in Oregon are private lands more critical for sustaining native habitats and wildlife than in the Willamette Valley. Landscapes here have changed immensely during the last 150 years. Prior to settlement by Europeans the valley was covered with a mosaic of oak woodlands, open savanna, prairie, wetlands, and occasional stands of conifer forest. Fire and seasonal flooding played a major role in the formation and maintenance of this mosaic. The mild climate and rich soils of the valley were attractive to early settlers, and today a patchwork of farms, suburbs, and cities have replaced much of the original mosaic. With fire suppression and flood control, many remaining undeveloped lands have been invaded by conifers, Oregon ash, and non-native species such as scotch broom and Himalayan blackberry (see Appendix A for plant common and scientific names used in this guide) and no longer resemble their historic condition.

Four general habitat types have been identified as broad-scale wildlife conservation priorities, based on assessment of historical changes and current management status: oak savanna and woodlands, wetlands, riparian and bottomland hardwoods, and native prairie grasslands.¹ Substantial portions of these habitats have been lost. Defenders of Wildlife, in *Oregon's Living Landscape*,² estimates that oak woodlands and savanna have been reduced by 80%, while wetlands have declined by 87%, and bottomland hardwoods 70%.

THE GREATEST OPPORTUNITY FOR IMPROVING OREGON'S ENVIRONMENT IN THIS GENERATION OCCURS ON LANDS THAT OREGONIANS CONTROL: ON STATE, COUNTY, AND PRIVATE LANDS. MUCH OF WHAT POTENTIALLY CAN BE ACHIEVED ON FEDERAL LANDS IS ALREADY REFLECTED IN NEW POLICIES AND PLANS FOR MANAGING FOREST AND RANGE LANDS. PRIVATE LANDS HAVE BECOME INCREASINGLY IMPORTANT TO SOLVING MANY OF OREGON'S ENVIRONMENTAL PROBLEMS FOR THIS GENERATION.

--Oregon State of the Environment Report, 20001

Virtually all of the native prairie is gone with less than 1% remaining.

Over 95% of the Willamette Valley is in private ownership.² The key to saving priority habitats is cooperation with land-owners. Conservation strategies need to focus on restoring and maintaining more natural ecosystem processes and functions

within landscapes that are managed primarily for other values. Although restoration and reestablishment strategies are important, strategies emphasizing more "habitat-friendly" management techniques for existing land uses are probably more practical. This recognition has led to the development of a number of federal and state landowner incentive programs (see Appendix C).

The State of Oregon's Wildlife Habitat Conservation and Management Program is a tax incentive program that rewards landowners for managing their property as wildlife habitat. In the Willamette Valley this program is being used to restore some of the important characteristics of the four priority habitats. This guide presents simple, non-technical practices for landowners and lay persons. Users of this guide should be aware that, although desirable, these practices are not "cookbook" recipes and will generally require modification to address the site-specific characteristics of their property. The organizations in Appendix D can provide assistance in identifying these characteristics and appropriate modifications to address them.

Habitat in the Willamette valley ranges from pavement and concrete to pure, diverse native plant communities. Restoration, as used in this guide, means changing habitat conditions on a site to conditions more like the pre-European settlement habitat. It does not mean complete re-creation of pure native habitats. In fact, it is doubtful that this is possible on much of the private land in the Willamette Valley because so little is typically known about the original detailed habitat structure on a specific piece of property. Even if detailed information is available, the costs and technical requirements are often not practical for most landowners. What the practices in this guide will do is create some facsimile of the habitat that once occurred on the area. In creating some of the structure and/or composition of the habitat thought to have originally existed prior to conversion, many of the functions of that system will also have been reestablished. Figure 1 (below) demonstrates restoration as used in this guide. The goal is to restore habitat on a project site by moving it up and to the right on the native species/diversity line.

This guide is organized by the four priority habitat types: oak woodlands; wetlands; bottomland hardwood and riparian forests; and grasslands and prairies. A brief discussion of each habitat is followed by restoration considerations and techniques. References or sources of information are denoted by superscript numbers that refer to entries in the bibliography. Restorationists wishing to obtain additional information or delve more deeply into a topic may want to review these references.

Many of the following techniques will require county, state or federal permits. Assistance with determining when permits are required and where to get them can be obtained by consulting the Oregon Watershed Enhancement Board's publication, *A Guide to Oregon Permits Issued by State & Federal Agencies With a Focus on Permits for Watershed Restoration Activities*.³ The organizations in Appendix D can also provide assistance.

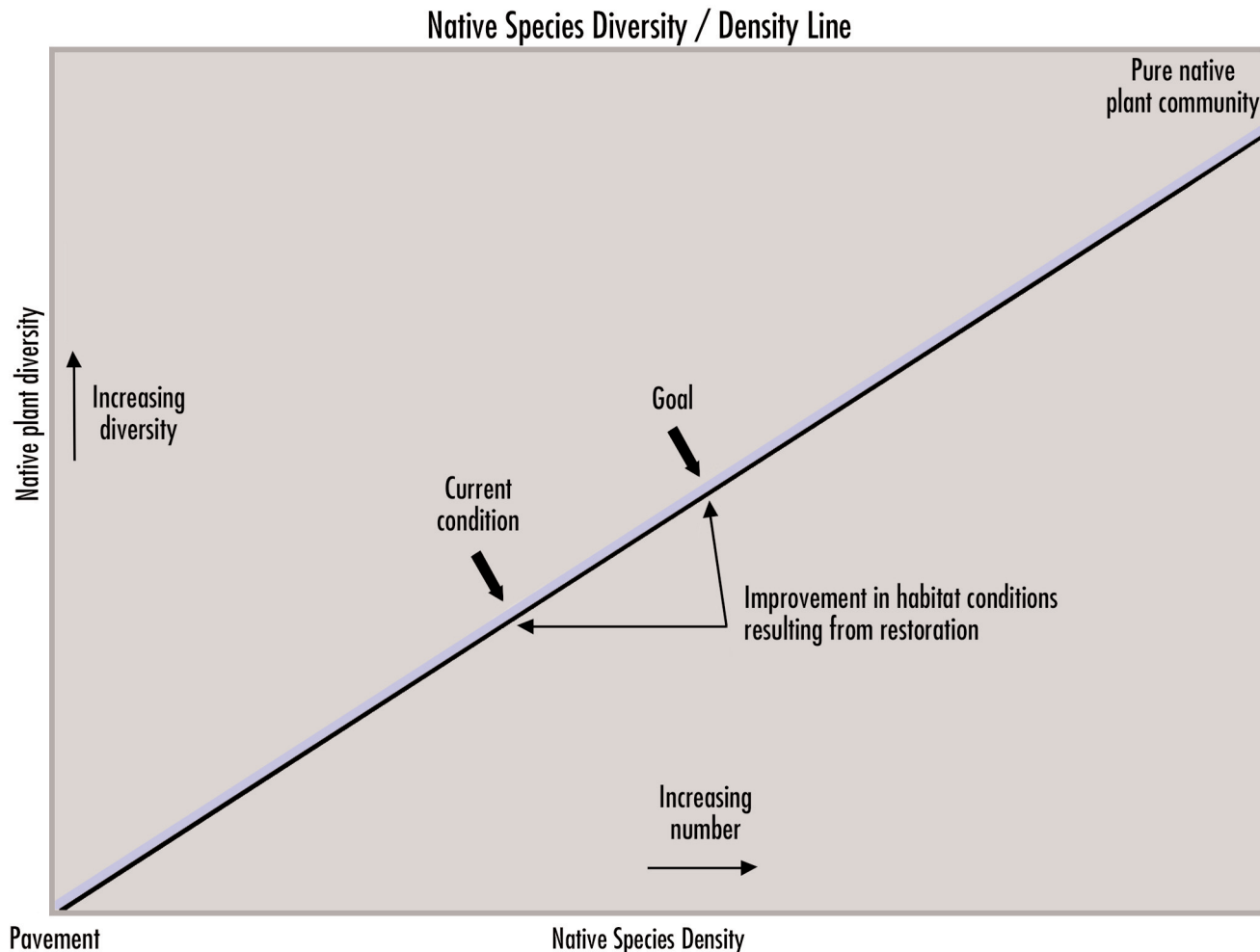
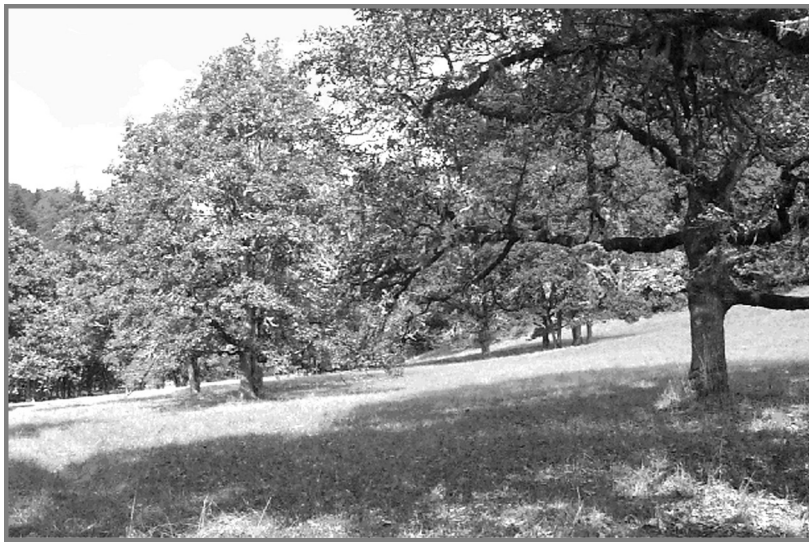

Figure 1. Restoration goals used in this guide.

Oak Woodlands and Savannas

Historically, Oregon white oak woodlands were a major component of the Willamette Valley landscape.^{4,5} This valuable plant community provides some degree of habitat for over 200 species of vertebrates such as the acorn woodpecker, western gray squirrel, white-breasted nuthatch, sharp-tailed snake, 10 species of bats, as well as a host of invertebrates^{2,7} (see Appendix H for a more comprehensive list). Distribution and maintenance of these woodlands is thought to have been primarily governed by fire, which suppressed competing vegetation and tree regeneration and promoted the development of widely-spaced, heavily-branched "open-form" oaks with thick, fire-resistant protective bark.^{4,7,8,9,10}

As European settlers cleared the valley and suppressed fires, oak woodlands and their many associated wildlife species began to disappear. Today many of the desirable places to live in the Willamette Valley are on the foothills or uplands formerly covered with oaks. Houses and small farms have replaced the native woodlands in these areas. Many of the remaining undeveloped areas are managed intensively for rapidly growing conifer trees to produce wood fiber, not the much slower growing oaks. On the valley floor much of the oak woodlands have been cleared for agriculture. Today only a few stands of oak remain, most either on foothills too rough to develop or around dwellings on old farmsteads.



Managed oak savanna at Mt. Pisgah County Park, Lane County, Oregon.
Photo by Bruce Campbell.

Most of the oak woodlands remaining in the Willamette Valley are in need of some type of management. While there are a few healthy, open stands of mixed-age trees, most stands occur as remnants in pastures or second-growth conifer forests. The structure of these stands ranges from clumps of young "closed-form" oaks to scattered geriatric, non-

reproductive trees. During the last decade considerable research and testing of restoration techniques has occurred, primarily in California. While these methods are for oaks native to California, many are likely applicable to Oregon white oak as well. *Regenerating Rangeland Oaks in California*¹¹ and *Techniques for Wildlife Habitat Management of Uplands*¹⁰⁹ are recommended as reference sources for anyone undertaking an oak restoration project. Many of the following recommendations are from these publications. The decision key for oak regeneration assessment¹¹ presented on pages 14-15 will assist with assessing the restoration potential of a site.

ENHANCING EXISTING OREGON WHITE OAK STANDS

CONIFER ENCROACHMENT

Oregon white oak will not tolerate shading and will not persist where over-crowned and shaded by other trees.^{12,13} In Oregon, only wholesale tree removal is a greater threat to

white oak than conifer encroachment.⁷ Conifer encroachment in the Willamette Valley is primarily by Douglas fir which, on wetter sites, can grow three to five times faster than Oregon white oak.¹⁴ Consequently, restoration of white oak stands, healthy or decadent, usually requires some type of conifer removal and control. Methods of removal and control will vary depending upon location. In rural areas where development is limited and liability from controlled burning is low, controlled or prescribed burns may be the most efficient method. In more developed areas and rural/urban interfaces where liability is much greater, controlled burns should not be used. In these situations, physical removal or killing of encroaching conifers is more practical. Some situations may be best addressed with a combination of physical removal of conifer and controlled burning.

PRESCRIBED BURNING. Prescribed burning is a very reliable method of reducing Douglas fir invasion where fuels are adequate to carry the fire.¹⁵ However, this tool is not appropriate for many sites due to the danger of wildfire and liability. For sites where burning is appropriate, extreme caution must be used during initial burning due to the likelihood of high fuel loads. Before conducting any prescribed burn, consult with the Oregon Department of Forestry. Appendix E lists the Oregon Department of Forestry offices in the Willamette Valley. In some rural areas the local rural fire district may, in cooperation with the Oregon Department of Forestry, conduct the burn as a training exercise. Prescribed burns should be conducted in the fall when fuels are abundant and combustible.

Where fuels, such as grasses, are adequate, it is possible to achieve a near-100% kill of Douglas fir seedlings with loss of less than 40% of the white oak seedlings.¹⁵ After a burn, the number of new oak seedlings often increases while Douglas fir seedlings become less common. Controlled burns in areas where fuels are comprised primarily of oak or conifer leaf debris are difficult to maintain and less successful in eradicating Douglas fir.¹⁵ Areas with serious Douglas fir encroachment and with high fuel loads should be reburned at 3-5 year intervals. Where oak sapling growth is critical or where fuel loading is not a problem, longer intervals of 5-10 years are recommended.^{16, 17} Scotch broom seeds are stimulated to germinate by fire, so a second burn 1-2 years after the initial burn will be necessary to control this noxious weed. Herbicides or mechanical removal are alternatives to a second burn. To reduce erosion and discourage weed establishment, burned areas should be seeded with native grasses listed in the Ground Cover section on page 11.⁷

TREE REMOVAL AND SNAG CREATION. Encroaching conifers may either be removed or killed and left standing to create snags. In stands where conifers are young (15 feet in height or less)

they can be cut flush with the ground and removed. In stands where encroaching conifers are larger (greater than 15 feet), they should be removed over a series of years to minimize the shock to oak trees resulting from opening of the forest. Larger trees may be harvested for market to generate funds for additional habitat conservation work or revenue to the landowner. If conifers are commercially harvested, they must be felled very carefully to avoid damaging oak trees, and soil disturbance and compaction should be minimized. Contact the local Oregon Department of Forestry office (Appendix E) for assistance and permits if commercial logging is to occur. Some trees may be felled and left lying on the ground to form woody debris, although this may provide a fire hazard or too much fuel if future controlled burns are planned to maintain the stand. Native grasses should be planted after conifer removal to reduce erosion and discourage weed establishment (see page 11 for more information).⁷

An alternative to removing encroaching conifers is to kill them and leave them in place. A number of techniques are available, including topping trees or girdling them. The latter is a simple, safe and effective method of killing Douglas fir. Frill cuts are made through the cambium around the trunk of the tree (girdling) and a solution of 50% glyphosate (Roundup®) is applied to the cuts.¹⁵ Cuts must be deep enough to prevent larger trees from healing-over and surviving. This treatment may be applied at any time of the year but early fall and spring are probably best.

OVER-CROWDING

Thinning. Historically, fire thinned oak stands, creating varying-aged stands and open savannas.¹⁸ These were characterized by widely spaced, heavily branched "open-form" oaks.^{4, 7, 8, 9, 10} Today, in the absence of fire, many oak woodlands have become dense, even-aged "dog-hair" thickets characterized by tall slender trees that are trying to outgrow their neighbors in a competition for sunlight. These stands can be restored to a historic condition, to some degree, by thinning. The extent to which widely spaced, heavily branched trees can be restored is dependent upon the age of the stand. Obviously, trees in a dense stand of 30-foot tall oaks will never develop into heavily branched "open-form" trees. Their crowns will, however, likely become more open relative to their original growth form. On the other hand, trees 10-15 feet tall still have the potential of becoming open-crowned after thinning. In either situation, thinning will increase structural diversity and wildlife habitat value.

Restoration goals should be determined before thinning occurs. Is the goal to develop an open oak savanna with widely spaced large, open-canopy trees, or to improve age-class and successional diversity without spacial decline of

oaks? Appropriate thinning and stocking rates for either goal are not well defined. Savannas may be characterized as having 5-30% tree cover.⁵¹ A maintained oak savanna in Mt. Pisgah Arboretum has a tree density of about 13 trees per acre (author, unpubl. data). Oak woodlands (30-60% tree cover⁵¹) would have a greater tree density. In the past, because of concerns that remaining trees might be damaged by the sudden exposure from a heavy release (thinning or removal of competing trees), thinning over a series of years was recommended. However, recent research at Ft. Lewis, Washington suggests that full release or thinning is not detrimental to the remaining oak trees.⁵² This type of thinning may actually be preferable as it reduces the likelihood of tree-damaging soil compaction that is often associated with multiple treatments. Whether the goal of thinning is to create savanna or improve age-class diversity, emphasis should be placed on retaining large trees (>20 in. diameter at breast-height [dbh]), medium trees (> 12 in. dbh), and trees with well formed, dominant crowns.⁷

Thinning of oaks in California to improve age-class and successional diversity is done in late summer or early fall.⁷ Similar timing, for either savanna restoration or improvement of age-class diversity, is probably appropriate in the Willamette Valley. Conversion of some oaks into snags is an alternative method of thinning. This can be accomplished by using the procedures discussed in the section on tree removal and snag creation, page 6. Appendix F is a list of companies that specialize in removing trees to restore habitats.

RESTORING HISTORIC OREGON WHITE OAK STANDS

The time required for reestablishing oak woodlands should be considered before committing to a restoration project. Oregon white oak often grows very slowly, putting on less than one foot of growth per year and taking well over 100 years to reach its maximum height of 60-70 feet.^{22, 23} It is not uncommon for a tree to exceed 250 years of age before developing a trunk diameter greater than 36 inches.²³ Consequently, successful oak woodland restoration projects require an exceptionally long commitment of several human generations.

PRE-PLANTING PREPARATION.

Site Selection. Restoration of oak stands should be attempted only in areas where oak grows or has grown naturally.¹¹ Much of the Willamette Valley has been cleared of its natural vegetation to provide lands for agriculture, cities, and homes, so current vegetation may not be a good indicator of a site's history or potential to grow oaks. Large-scale maps of presettlement vegetation of Oregon^{2, 24} provide a gross idea of where white oak woodlands occurred in the past, but they lack enough detail to provide site-specific information. The

presence of oaks on similar nearby sites, soils, elevation, and climate all aid in identifying suitable sites.

Oregon white oak grows in several different settings. Oaks persist on the poorly drained, heavy clay and coarse-textured soils of floodplains and river terraces that are very wet in the winter but droughty in the summer (see Section 4 Bottomland Hardwood and Riparian Forest for more about this growth-form). They also thrive on exposed, droughty soils of upland areas.²² Oaks are most likely to be associated with sedimentary soils such as Steiwer, Carlton, and Peavine, but are not uncommon on basic igneous soils such as Nekia and Dixonville.⁸ White oak is known to occur from sea level to 3,800 feet elevation in the northern portion of its range and up to 7,500 feet at the southern end of its range.²² In the Willamette Valley it is most common below 1,200 feet, with the upland growth-form occurring on the lower foothills of the Coast Range and Cascades as well as the low basalt hills and glacial terminal moraines scattered throughout the valley. Oak forests tend to occur on the middle and upper two-thirds of north- and east-facing slopes of less than 30% gradient.⁸ The climate favorable to Oregon white oak is extreme summer drought and annual precipitation of 10 to 100 inches. The species is well adapted to hot, dry conditions and, with adequate moisture early in the season, will thrive where severe summer drought limits other tree species.²²

Seeds or Seedlings? Oak woodlands and savannas can be reestablished by planting oak acorns or oak seedlings. Both approaches have advantages and disadvantages. Tests have shown little difference in the survival rates for directly sowed and seedling planted blue oak, although acorns did provide plants with greater growth than 1-year-old seedlings.¹¹ Acorn collection and direct seeding is generally easier and less expensive than planting seedlings, but is not advisable in areas with a high potential for rodent predation.²⁵ Commercial availability of seedlings from local seed sources may be limited, but nursery culturing of white oak is easy. The following is a summary of published techniques and recommendations for acorn collection, storage, direct planting, and rearing of seedlings.

Acorn Collection and Storage. Growth habit, rate, and other characteristics can vary greatly among white oak populations that have developed under different environmental conditions. Consequently, acorns should be collected from local trees growing in conditions similar to those of the reestablishment site.^{11, 25} Oregon white oak flowers in April and May and acorns require only one growing season to mature, ripening in September and October.^{23, 25} Because immature acorns cannot be ripened artificially after picking,²⁶ acorns should be collected shortly after they are physiologically mature. The easiest and best characteristic of ripe acorns is the ease with which they can be dislodged from the

acorn cupule or cap. When ripe, acorns can be easily removed from the cap by gentle twisting. If they are not ripe, the caps are difficult to remove and some of the fleshy meat may be torn off the acorn when separated.^{11, 25}

The best quality acorns are generally collected off the tree before they fall. An efficient method of harvesting is to shake acorns from the trees onto tarps, or pick them from the branches. Acorns can be collected off the ground. However, those that are lightweight, dried, or insect-damaged should be discarded. Viable acorns will look plump and have a dark color. Sometimes immature acorns will fall with caps intact in late summer; these are not viable and should be avoided.²⁵

Acorns may be stored until time to plant but require proper storage to maintain their viability. White oak acorns have no embryo dormancy and will begin germinating unless refrigerated at temperatures 33–41 F°.^{11, 25, 27} The easiest way to store them is in 1-gallon zip-lock plastic bags. Fill bags half-full with acorns and add a handful of dry peat moss, perlite, or a 3:1 mixture of perlite and vermiculite.^{25, 27} The peat is slightly acidic, which inhibits bacterial growth, and absorbs excess moisture. Do not seal bags, as some gaseous exchange from respiration occurs in viable acorns.²⁷ Airtight storage containers should not be used. To retard mold, fungicides such as Captan® may be placed in bags.^{11, 27, 28} Do not let acorns dry during storage as they are quite sensitive and their ability to germinate decreases with loss of moisture.^{11, 25}

Acorns can be sorted prior to planting using a float test.^{11, 25} Place acorns into a sufficiently large container filled with water, stir, and let them set for several hours to either settle to the bottom or float. “Floaters” are removed and discarded. This process should be repeated several times. Acorns may be stored for up to a week before planting.²⁷

GERMINATING AND PLANTING ACORNS

DIRECT PLANTING.

On many sites, directly planting acorns instead of seedlings is the best method for starting oaks. White oaks have no embryo dormancy and need no special environmental conditions prior to germination.^{11, 23} Under natural conditions germination occurs in late fall to early spring, however, seeds will germinate soon after dispersal under warm, moist conditions.²² Direct planting is best done in the fall,²² but planting should not occur until after there has been sufficient rainfall to soak the soil to a depth of approximately 8 inches.²⁵ The best seedbed is moist, well-aerated soil with 1 inch or more of leaf litter.²³ Acorns should be planted approximately 1-inch deep.²⁷ Some restoration ecologists recommend that several acorns be planted at each location to insure germination of at least one individual.²⁵ Multiple

seedlings can later be thinned to the single most vigorous plant. Shelters are recommended (see Seedling Protection, page 9).

Pre-germination of acorns before planting can enhance initial seedling establishment by over 90%.¹¹ Pre-germination can be accomplished by filling pie pans or similar shallow containers with moist vermiculite, sand, or peat. Acorns are placed on their sides and gently pressed into the medium. The medium should stay moist but not overly saturated while acorns germinate. Containers can be placed on a table, windowsill, or bench and maintained at room temperature. The radicle, or initial root shoot, should appear within a few days. Acorns can be planted once the radicle appears using a pencil, screwdriver, or other pointed tool to make a hole in the soil. Acorns should be carefully positioned in the hole with the radicle down, making sure that the radicle is not “J-rooted”. Cover with ½ - 1 inch of soil.

NURSERY PROPAGATION.

Oregon white oak also lends itself well to nursery propagation. Acorns collected in the fall and grown in plant tubes will produce seedlings that can be field planted by the following fall or winter.^{11, 25} Properly handled acorns (see acorn collection and storage recommendations above) often have germination rates of over 90%. Acorns can be pre-germinated as described above or planted directly into tubes. Tubes should be filled with a well-drained growing medium such as a mixture of equal parts peat moss, crushed lava rock, and perlite.²⁵ Another commonly used potting mix is 5 cubic feet of coarse peat moss; 5 cubic feet coarse vermiculite; 4 cubic feet of 1/8 to 1/4 inch-sized fir bark; 1 pound of lime; and 2 pounds of slow-release fertilizer granules.¹¹ Acorns planted directly into tubes should be placed with the pointed tip buried halfway and at an approximately 45-degree angle.

Deformed taproots can be a serious problem in seedlings that are not properly potted. Oak seedlings tend to put a large amount of energy into producing a taproot and can quickly become pot-bound if containers are too small. These seedlings are poorly adapted to growing in the field and have low survival rates, very slow growth rates, and produce trees with poor stability. To avoid this, many nurseries start oaks in small sleeves called liners, or in flats. As they grow, seedlings are transplanted into larger “treetops” with dimensions of approximately 4 in. x 4 in. x 14 in. or small milk carton-like boxes measuring 2 in. x 2 in. x 10 in.¹¹

Deformed roots may be further prevented by root pruning. Two methods are common: air pruning and chemical pruning.¹¹ Air pruning uses open-ended containers that are placed on screens to prevent the planting medium from falling out. The taproot is exposed to the dry air once it reaches the bottom of the container and, since roots need

moisture, stops growing. This, in turn, causes the production of lateral roots farther up the main root, creating a much more fibrous root system. Chemical pruning uses copper compounds that can be painted on the interior of containers. These compounds arrest the growth of root tips when the roots come in contact with them, causing root branching and development of a more fibrous root system.

SEEDLING CARE.

While in the nursery, oak seedlings should receive regular, thorough irrigation during the dry season.²⁵ To maintain an adequate oxygen level in the container, the growing medium should remain slightly moist and never be allowed to dry out completely. If grown outside, seedlings should be placed in partial shade to prevent tubes from drying out too quickly.

Container seedlings planted in a medium lacking a time-release fertilizer will need to be fertilized within a few weeks of planting.¹¹ Fertilizer can be provided in irrigation water using a fertilization regime of 20-20-20 at 100 parts per million of nitrogen plus micronutrients.

BAREROOT STOCK.

Oak seedlings can also be raised as bareroot stock.¹¹ To do this, sow acorns in nursery beds by the end of January at a density of no more than 12 to 14 per square foot. Undercut seedling roots in May and August to inhibit taproot development and promote a fibrous root system. Lift seedlings no later than early February and place in cold storage, making sure roots stay moist. Seedlings may be stored for up to two months but avoid extended storage for late-lifted stock.

SITE PREPARATION AND PLANTING

SEEDLINGS.

Site preparation is very important for successful establishment of oak seedlings.²² If direct seeding is to occur, compacted soils should be disked at least twice in late summer to a depth of at least 6 inches, and preferably 8 to 15 inches, before planting.³⁶ Competition from weeds, grass, and seedlings of other tree species may be the most important obstacle to seedling establishment and growth.²⁸ Weed control should be used during the first 2-3 growing seasons to minimize this competition.^{11, 29} The choice of a method of weed control, be it

herbicides, physical removal, or mulching, will depend on environmental, financial, and philosophical considerations. Maintain a weed-free circle 4 feet in diameter around seedlings with landscape fabric, organic or inorganic mulches, or herbicides.^{11, 12, 25} If herbicides are used, the area of control should be extended to a 6-foot diameter. Hardware cloth should be anchored with heavy-gauge wire staples to keep it in place. Weed control should be initiated by early spring of the first year to ensure that weeds don't become established before the seedlings.

Container-grown seedlings are planted in January to March in Central California.¹¹ Similar timing is probably appropriate for the Willamette Valley. Care should be taken to insure that planting holes are deep enough to prevent "J-rooting" or turning the tip of the taproot up. Power augers or post hole diggers are recommended. Figure 2 (below) illustrates common problems encountered during tree planting that should be avoided.

SEEDLING PROTECTION.

New plantings are vulnerable to damage from animals. To reduce damage from deer, rodents, grasshoppers and other surface plant predators, a "collar and screen" planting technique²⁵ or treeshelter¹¹ should be used. If livestock are present, additional protection such as exclosures or cages may be necessary.

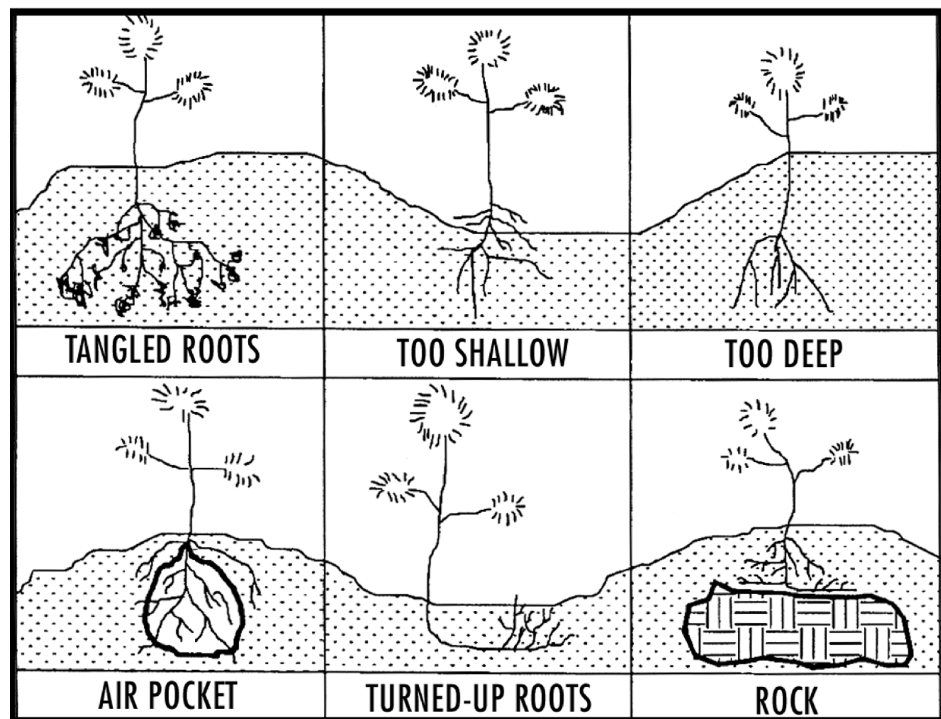

Figure 2. Problems to avoid during tree planting. Image courtesy of the California Department of Fish and Game.

The “collar and screen” planting technique involves a collar around each seedling, which stabilizes the soil, provides a basin for watering, if needed, and provides an anchor for the protective screen.¹¹ Collars can be made from one-quart plastic dairy containers with the bottom removed, and the protective screen is made of aluminum window screen. Do not use plastic or fiberglass screen as rodents can chew through them. The screen is cut into 18-inch squares, rolled into cylinders, with the top folded and stapled shut.

Commercially available tree shelters are translucent protectors that fit over seedlings. Most are made of twin-wall polypropylene that deteriorates over time. An advantage of treeshelters is that they are reported to stimulate above-ground growth due to their “mini-greenhouse” effect. Tree shelters are available in a number of heights, and the appropriate size will depend upon the browsing height of the animals to be excluded. Shelters more than 1 foot tall require staking or metal post support if livestock are present. Stakes should be durable enough to last the length of time treeshelters will be in place. Oak or bamboo stakes provided by the manufacturer are generally adequate. Shelters should be secured to the stakes, possibly with plastic ratchet clips or wire. Make sure that the tops of stakes are lower than the tops of the shelters to prevent access by rodents that can climb. Access by birds can be prevented by placing netting over the tops of the shelters. Livestock can be excluded by weaving flexible wire through the top of the shelter instead of using plastic netting.

Exclosures can be constructed with field fence supported by metal posts at the corners. A typical design is a 5-foot square and 4 feet tall. A circular cage or vaca cage can be used in lieu of exclosures. They are constructed out of galvanized 12 gauge wire fencing with welded 2 in. x 4 in. mesh and supported by metal posts. Cages are typically 4 feet tall and 1.5 feet in diameter. They may be secured to the ground with a “T” post or reinforcing bar.

Seedlings may also be attacked underground by gophers and ground squirrels. While repellents and poison baits may be effective in reducing this type of seedling predation, they are discouraged. An alternative is installation of commercially available “root guards” around the roots of seedlings when they are planted.

FERTILIZATION, IRRIGATION, AND PRUNING AFTER PLANTING.

Fertilization tests with oak seedlings have provided mixed results. The results of application of granular, slow release fertilizer (18-6-12) to blue and valley oak transplants at the time of planting were negative.³⁰ However, annual fertilization with 1/4 lb. per seedling of 16-20-0 enhanced survival and growth of California black oak.³¹ If fertilizer is used, .74 ounce, slow-release fertilizer tablets (20-10-5)

should be placed 3-4 in. below seedlings at the time of planting.¹¹

While large-scale irrigation is generally not practical, irrigation can greatly improve the chances of seedling establishment and growth.¹¹ An irrigation rate of 1 gallon of water every 4 weeks enhanced seedling growth in the Sierra foothills of California³² and may be appropriate for the Willamette Valley. A good moisture-conserving mulch is probably just as effective on all but the driest sites. Earthen basins 1-2 feet wide around seedlings may be used on steep slopes or where a large quantity of water can be added and left to soak in.

There may be benefits from top-pruning oak seedlings just after planting. This creates plants of more uniform size and favorable shoot-to-root ratios.

TREE SHELTER MAINTENANCE AND FOLLOW-UP.

Carefully timed maintenance visits are the key to successful oak establishment.²⁵ Unirrigated sites should be visited twice per year, once in the spring and once in the fall. Make sure shelters are upright, attached to the stake, buried in the ground, and functioning properly. Weeding inside the collar and between the collar and fabric is essential. Keep a 4-foot diameter circle around the shelter free of weeds. Replace broken or missing stakes and damaged screen as necessary. If the oak seedling is growing vigorously and could reach the screen top before the next visit, the screen top should be opened. An open screen still provides protection to the trunk of the seedling from herbivore damage. Maintenance is generally only needed for two to three years, however, where weeds are abundant and seedling growth slow, maintenance may be required for up to five years. Eventually, all hardware should be removed.

ADDITIONAL CONSIDERATIONS FOR ALL TYPES OF RESTORATION

DISEASE.

Oaks are susceptible to several diseases, pathogens, and damaging insects.^{11, 22, 33} Filbertworm (*Melissopus latiferreanus*) and filbert weevils (*Curculio occidentalis*) attack acorns and lay their eggs inside. Larva feed on the cotyledons of the embryo in the shell. Western oak looper (*Lambdina fiscellaria*) defoliate trees. Tent caterpillars have a preference for oaks and gall wasps are common on Oregon white oak. Infestations of woolly aphids can be a problem on seedlings in tree shelters that are 4-7 F° warmer than ambient temperature.

Pathogens to watch for include shoestring root rot (*Armillaria ostoyae* and *A. mallea*) and white pocket root and butt rot (*Polyporus dryophilus*). Anthracnose disease

(*Gnomonia quercina*) has caused significant damage to white oaks in Washington. Hairy mistletoe is widespread in oaks and can be a problem, even though it is a native species and important to wildlife.

A comprehensive listing of diseases and insects that affect native California oaks, and in most cases is also applicable to Oregon, is contained in a host index database called CODA. In 2001 this database contained information on 1,259 agents that affect oaks and 320 references that discuss the effects of these agents on oaks. It can be downloaded for free at <http://www.phytosphere.com>.

GROUND COVER.

Open grasslands are a major characteristic of oak savannas. Areas of ground will be exposed as dense oak stands are opened-up or seedlings are planted. These areas should be planted into common dry prairie grasses such as Roemer fescue, Idaho fescue, California oatgrass, Junegrass, slender wheatgrass, blue wild rye, and Lemmon's needlegrass.^{7, 20} Common shrubs such as ocean spray, oval-leaf viburnum, serviceberry, snowberry, Indian plum, tall Oregon grape, hawthorn, nootkana rose and baldhip rose should also be planted or encouraged.^{7, 8, 20, 22} In savannas shrubs should cover about 10% of the open grassland. Appendix B provides seeding rates and planting depths for some common native plants including those found in oak woodlands and savanna.

Native ground cover may be transplanted from adjacent areas or obtained from commercial outlets. If seedlings or rootstock are transplanted, appropriate timing and techniques are necessary for success. These vary by species and are beyond the scope of this manual. A good reference source for this information is *Propagation of Pacific Northwest Native Plants*.³⁴ Some rare plants are protected or require permits to collect. Permits are also required to remove plants from public lands. See Appendix G for permit requirements and where to obtain permits.

Native ground cover can also be established by collecting and sowing seed directly on the restoration site or by germinating collected seed in a nursery for later transplant to the site. However, these methods are discouraged because they are often complicated and time-consuming. An economical alternative is obtaining seed or plants from a commercial outlet. A number of outlets in the Willamette Valley offer established native shrubs, grasses, and forbs (Appendix A).

GRAZING.

Low-impact grazing — defined by the timing and amount of vegetation removed — may occur if the proper precautions are taken.⁷ Grazing should be limited to early spring through early summer, or until seed heads form. It

should cease before 25% of the herbaceous layer has been consumed or the herbaceous layer is cropped to within 4-6 inches of the ground, whichever comes first. These conditions usually occur in less than six weeks of grazing. Rotate grazing areas to allow recovery of vegetation and to allow oak regeneration to occur.⁷ Grazing is not recommended if oak sprouting and sapling growth are being encouraged, where acorn production is desired, or in riparian zones.

Grazing may be allowed in late summer and fall to reduce rank vegetation where fire danger is a concern. Again, grazing should cease when the herbaceous layer is cropped to within 4-6 in. of the ground. If grazing is allowed in areas where oak savanna is being restored, the period between April 15 and July 15 should be avoided to protect ground-nesting birds.¹⁹ If restoration includes plantings of oak seeds or seedlings, protection from cattle is essential for their growth and survival.²¹ In restored oak savanna where grasses and forbs have been planted, the condition of these plants and their tolerance to grazing should be determined before grazing is allowed.

CONTROL OF INVASIVE EXOTICS

Regardless of the type of restoration undertaken, periodic control of exotic or non-native invasive plants such as scotch broom and blackberries will be necessary to keep them from over-running open areas. The following are accepted methods of control for these aggressive species. The Oregon Department of Agriculture-Noxious Weed Control Program (Appendix D) can also provide advice.

Blackberries.⁶³ Himalayan blackberry is native to Western Europe and was probably introduced into North America in the late 1800s as a cultivated crop. It is a robust, sprawling, weak-stemmed shrub. The stems, called canes, grow upright at first, then cascade onto surrounding vegetation, forming large mounds or thickets. While some canes stay erect, growing up to 9 feet high, many become trailing, growing 20-40 feet long. Stems, leaf stalks and leaves are thorny. The leaves are palmate, usually with five large, oval, toothed leaflets. The leaflets are dark green on the upper surface and grayish-green below. Flowers are white to light pink flowers and produce a large, juicy, berry. The berries, which ripen between mid-summer and autumn, are used as food by birds, humans and other mammals. Individual canes, which generally live only two years, produce berries in their second year. Himalayan blackberry can be evergreen, depending on the site.

Evergreen blackberry was also introduced from Eurasia as a cultivated plant. While not as invasive as Himalayan blackberry, evergreen blackberry does take over native

vegetation. It is a semi-erect shrub, growing to 10 feet tall. Stems are generally biennial, bearing fruit in their second year, and grow from perennial rootstock. As the name indicates, the leaves are evergreen and deeply incised. Each leaf has five leaflets, which have very divided edges, quite different from Himalayan blackberries. The leaves are green on both sides, hairy on the underside, and the plant is very thorny. The flowers are white to pink and the berries are black, ripening between midsummer and autumn.

Both Himalayan and evergreen blackberries are very aggressive, reproducing both vegetatively and through seed production. Both displace native vegetation such as snow berry and wild rose. Seeds, which can remain viable for a long time, are spread by both humans and wildlife. Both species form suckers off roots, and canes will root when they touch the ground, forming new plants. New plants will also readily grow from pieces of root or cane. Both Himalayan and evergreen blackberry grow in a wide variety of habitats and soil types, quickly forming impenetrable thickets of both dead and live canes. They do especially well on disturbed sites.

Both Himalayan and evergreen blackberries can be controlled through mechanical and chemical means. Seedlings can be hand-pulled, especially in loose soil. Plants can also be hand-dug, but care should be taken to remove all of the roots to prevent resprouting. Mowing is used to control blackberries, but it must be repeated throughout the growing season for at least three years. Cutting and removing canes is a short-term solution, as more canes will sprout from the root crown. However, these new sprouts can subsequently be treated with herbicide. If canes can only be removed once in a season, the best time is when the plant starts to flower, since much of the root reserves have gone into flowering.

Blackberries can also be controlled through chemical means, although some herbicides can promote vegetative growth from lateral roots. RoundUp®, Crossbow®, Escort®, and Garlon® 3A or 4 are very effective on blackberries (see *Pacific Northwest Weed Control Handbook*⁶² for other possible herbicides). RoundUp® should be mixed with a surfactant and applied at the manufacturer's suggested application rate. Best results are obtained if applied to foliage in September or October when canes are actively growing and after berries have been formed. Another option is Garlon® 3A or 4 or Crossbow® mixed with a surfactant and applied to actively growing plants at the manufacturer's suggested application rate. Cut stumps can be treated with either a Garlon® 4 (20% Garlon® and 80% oil) or Crossbow® (40% Crossbow® and 60% oil) mix. Both mixes are applied directly to recently cut stems using a hand spray bottle, paint roller, or other low-volume applicator.

Crossbow® and some other herbicides contain 2-4-D which can drift damage crops and native species. Follow the label and application instructions, and use extreme caution.

Scotch (Scot's) Broom.⁶⁷ Scotch broom, which was originally introduced as an ornamental, is a perennial shrub member of the pea or clover family. It is an aggressive competitor that can grow rapidly to heights of over 6 feet and live for up to 20 years, forming dense thickets. The species, which is drought and cold tolerant, can rapidly invade disturbed areas, suppressing or displacing native species. Other characteristics of scotch broom that promote its invasiveness include its profuse seed production, longevity of seeds (>30 yrs.), deep roots, ability to resprout from stumps, and its adaptability and lack of natural enemies.

Scotch broom can be controlled by hand removal, cutting, herbicides, burning and biological control. Hand pulling can be effective if the entire stump and roots are removed, soil disturbance is minimized, and care is taken to not spread seeds. A tool called a Weed Wrench® can be used to pull broom up to 2 ½ inches stem diameter and is effective in removing the root. The best time to hand-pull is during spring, fall, and winter when soils are moist. The biggest disadvantage to pulling is that it is labor intensive and needs to be repeated over a number of years because of the ability of missed roots to resprout and dropped seeds to germinate. Pulling can also disturb the soil, creating ideal conditions for reestablishment by seed.

Straight blading, brush rakes, and hydro-axes can be used to uproot, pile or crush scotch broom thickets.⁶⁸ However, mechanical cutting with bulldozers or other equipment is expensive and heavily disturbs the soil making conditions ideal for broom resprouting and seed germination. Repeated cultivation or herbicide applications will destroy seedlings but will also limit native species restoration. Seeds adhering to equipment may also be distributed into the disturbed areas or new areas.

Mowing can be used to control established scotch broom plants. Optimum time for mowing is after blooming and during the seed-pod formation period. This will prevent seed production and control light infestations but can encourage branching and development of meadows of vegetatively reproducing scotch broom.

Scotch broom can be controlled by herbicides. Selective applications that target the broom will minimally impact surrounding desirable vegetation. Herbicide treatment provides good control at any stage of plant growth during the growing season. However, application during blooming, post-blooming, and seed-pod formation are most effective. Good spray coverage of the entire plant and use of a spray

sticker-spreader will maximize the effectiveness. Herbicides commonly used include Crossbow®, Weedmaster®, 2,4-D, Garlon 3®, and Garlon 4®. Refer to the current edition of *Pacific Northwest Weed Control Handbook*⁶² for additional herbicides and application rates.

BOX 1

SCOTCH BROOM

A typical seasonal treatment schedule using a combination of control methods might be:

SPRING:

- **Mechanical:** Cut all plants to 1/4 inches at butt; pull all smaller plants by hand with weed wrench or tractor and chain. Mowing with a heavy-duty tractor-mounted flail mower is also effective.
- **Chemical:** Spot spray all plants with Crossbow® or RoundUp®. Basal bark or cut stub treatment effective.

SUMMER:

- **Mechanical:** Same as spring but **before** seeds mature.
- **Chemical:** Same as spring.

FALL:

- **Mechanical:** Don't cut or remove broom until after the seed has matured and dispersed naturally; after that, cut all plants >3 inches butt diameter; uproot all smaller plants.
- **Chemical:** Limited effectiveness during this season. Basal bark or cut stub treatment effective.

WINTER:

- **Mechanical:** Same as spring.
- **Chemical:** Same as spring.

Goats may be useful in controlling scotch broom but the effectiveness of this technique has not been established. Parasitic insects, mites, and fungal pathogens have also been tried as bio-controls but have not been effective.

False-Brome.⁸⁶ This invasive perennial grass is a relatively new problem in the Pacific Northwest. It is a native of

Europe, Asia, and Africa and is capable of completely dominating understory and open habitats to the exclusion of most native species. It was first found in North America in 1939 near Eugene and by 1966 had grown to at least two colonies in the Corvallis-Albany area. Currently it is only known in North America in Oregon, where it is found in the Willamette Valley, coastal forests, and as far south as a few miles north of the California boarder.

False-brome can be differentiated from other grasses by its hairy leaf margins and lower stems, broad (0.2-0.4 inches) lax leaves, and long-lasting bright green color. Leaves often remain green through the fall and at least part of the winter. It differs from native perennial bromes by having sheaths open to the base, flowers borne in a true spike, and spikelets with no or only short stalks. The flower spikes droop noticeably. In comparison, the perennial bromes in the Valley have sheaths closed >1/4 of their length; flowers are in more open, branched panicles; and spikelets are generally strongly stocked. While spikelets droop on one native, Columbia brome, the spikelets are clearly stalked.

In the Willamette Valley false-brome occurs in conifer and upland hardwood forests, open areas such as pastures and prairies, and in riparian areas. It can be found with native grasses such as Columbia brome, bearded fescue, and oniongrass in forest understories, and blue wildrye, California brome, California oat-grass, and California fescue in open areas such as upland prairies. False-brome is not rhizomatous and reproduces rapidly from seed.

False-brome becomes a serious pest after timber harvest and may inhibit reforestation. It may also invade pastures and reduce forage quality for livestock and wildlife. When the species dominates a community, it may have negative effects on small and large mammals, native insects, lizards, snakes, and birds. This grass may reduce establishment of planted riparian trees that provide shade and structure to streams.

False-brome can be effectively removed or controlled with Roundup® but mowing and burning appear to be ineffective. Hand removal may work in small patches but care must be taken to remove all of the root fragments. Additional information can be obtained at:

<http://tncweeds.ucdavis.edu/alert/alrtbrac.html>

<http://www.ou.edu/cas/botany-micro/ben/ben277.html>

<http://www.appliedeco.org/reports.html>

BOX 2**OAK MANAGEMENT DECISION KEY**

1. If the land is wooded (with a canopy cover less than 75%), go to 2 (if not, go to 9).
2. If trees include mature open canopy oaks or open canopy trees greater than 20 inches, go to 3 (if not, go to 5).
3. If trees are scattered with few species other than oak, consider restoration option A1 or A2. (if not, go to 4).
4. If trees are scattered and are intermixed with other species, consider restoration options B1 or B2 (if not, go to 6).
5. If trees are thick, predominately oak less than 20 inches in diameter, and have a tall, small canopy growth form, consider restoration C1-C4. (if not, go to 7).
6. If trees are a mix of scattered open canopy oaks intermixed with denser stand of tall, small canopy oaks (oak woodland), consider restoration C1-C4. If trees are a mix of scattered open canopy oaks intermixed with denser stand of conifers, consider restoration options D1 or D2.
7. If trees are predominately conifers with some tall growth form oak less than 20 inches in diameter, consider restoration options D1 or D2. (if not, go to 8).
8. If trees are predominately species other than oak but area is believed to have once supported oak, consider restoration options E1 or E2. (If not, area is probably not appropriate for restoring Oregon white oak. Reevaluate management objectives and consider restoring some other appropriate habitat).
9. If land is not wooded and is in an area thought to have once supported Oregon white oak, go to 10 (If not, the area is probably not appropriate for restoring Oregon white oak. Reevaluate management objectives and consider restoring some other appropriate habitat).
10. If vegetation consists principally of native grasses, forbs, and shrubs, and oak savanna or woodland is the management goal, consider restoration option E1 or E2. (If not, go to 11).
11. If vegetation consists primarily of exotic or weedy species, consider restoration options F1 - F3.

A1. SAVANNA MANAGEMENT: Maintain open condition by burning, mowing, or lightly grazing one-third of the site every spring or fall on a revolving schedule. Maintain clumps of native shrubs on 10% or less of area. Remove problem weeds. See *Degraded Woodland Management*(1). See *Enhancing Existing Oregon White Oak Stands* for management details.

A2. SAVANNA MANAGEMENT WITH INTERSEEDING: Manage as in A1 except in addition, plant native grasses and forbs. See *Enhancing Existing Oregon White Oak Stands* for management details.

B1. SAVANNA MANAGEMENT WITH TREE REMOVAL: Where weeds not a problem, manage as in A1 except in addition, remove undesirable trees (e.g. volunteer fruit trees, hawthorn, and ash). See *Enhancing Existing Oregon White Oak Stands* for management details.

B2. SAVANNA MANAGEMENT WITH TREE REMOVAL AND INTERSEEDING: Manage as in B1 except in addition, plant native grasses and forbs. See *Enhancing Existing Oregon White Oak Stands* for management details.

C1. WOODLAND MANAGEMENT: Where weeds not a problem, thin oaks to open canopy and improve tree age-class and successional diversity. Target oak tree cover of 30-60%. Maintain open areas by burning, mowing, or lightly grazing one-third of the site every spring or fall on a revolving schedule. Allow natural ground cover and understory to become established. Control exotics. See *Enhancing Existing Oregon White Oak Stands* for management details.

C2. WOODLAND MANAGEMENT WITH INTERSEEDING: Target oak tree cover of 30-60%. Plant native shrubs, grasses and forbs to prevent weed establishment. Maintain open areas by burning, mowing, or lightly grazing one-third of the site every spring or fall on a revolving schedule. Control invading exotics. See *Enhancing Existing Oregon White Oak Stands* for management details.

OAK MANAGEMENT DECISION KEY, continued

- C3. **SAVANNA RESTORATION:** Thin oaks to a tree density of 3-7 per acre. Manage as in A1. See *Enhancing Existing Oregon White Oak Stands* for management details.
- C4. **SAVANNA RESTORATION WITH INTERSEEDING:** Thin oaks to a tree density of 3-7 per acre. Manage as in A1 except in addition, plant native grasses and forbs. See *Enhancing Existing Oregon White Oak Stands* for management details.
- D.1 **WOODLAND/SAVANNA MANAGEMENT:** Where weeds not a problem, remove and control conifers by prescribed burning, mechanical methods, or herbicides. Goal of 3-7 oak trees per acre if savanna is management objective or oak tree cover of 30-60% (natural regeneration necessary) if oak woodland is management objective. Maintain by burning, mowing, or lightly grazing one-third of the site every spring or fall on a revolving schedule. Allow natural ground cover and understory to become established. Control invading exotics. See *Enhancing Existing Oregon White Oak Stands*, Conifer Encroachment for management details.
- D2. **WOODLAND/SAVANNA MANAGEMENT WITH INTERSEEDING:** Manage as in D1 except in addition, plant native grasses and forbs. See *Enhancing Existing Oregon White Oak Stands*, Conifer Encroachment for management details.
- E1. **WOODLAND RESTORATION:** Clear area of all trees by prescribed burning, mechanical methods, or herbicides. Prepare area for planting and plant to obtain 30-60% oak tree cover. Plant understory, grasses and forbs. Control invasive exotic vegetation. See *Restoring Historic Oregon White Oak Stands* for management details.
- E2. **SAVANNA RESTORATION:** Manage as in E1 except plant oaks at a density that will yield 3-7 trees per acre when mature. (Initial seeding/planting density will be >3-7/acre with thinnings as trees grow.) See *Restoring Historic Oregon White Oak Stands* for management details.
- F1. **WOODLAND RESTORATION:** Clear all vegetation by prescribed burning, mechanical methods, or herbicides. Prepare area for planting and plant to obtain 30-60% oak tree cover. Plant understory, grasses and forbs. Control invasive exotic vegetation. See *Restoring Historic Oregon White Oak Stands* for management details.
- F2. **SAVANNA RESTORATION:** Manage as in F1 except plant oaks at a density that will yield 3-7 trees per acre when mature. (Initial seeding/planting density will be >3-7/acre with thinnings as trees grow.) See *Restoring Historic Oregon White Oak Stands* for management details.
- F3. **Reevaluate management objectives and consider restoring some other appropriate habitat.**

Wetlands

Wetlands are found in the transitions between terrestrial and aquatic systems where the water table is usually at or near the surface or the land is covered by shallow water. Wetlands have one or more of the following attributes: at least periodically, the land supports predominantly hydrophytes (plants that survive on permanently or seasonally saturated soils); substrate is predominantly undrained hydric or saturated soils; the substrate is nonsoil and is saturated with water or covered by shallow water at some time during the growing season of most years.³⁵ Wetlands can occur in river bottoms, wooded areas, grasslands, and uplands. In some instances, when the water table is below the surface during dry periods, they can seasonally be very dry.

Wetlands provide a wide range of important functions and values.^{37, 38} They form natural floodways that convey floodwaters from upstream to downstream areas; reduce flood peaks by storing water during floods and then slowly release it over a period of time; reduce flood velocities and erosion, and trap water-borne sediments; improve water quality by removing excess nutrients and chemical contaminants; and recharge ground water supplies. Wetlands also provide important spawning and rearing areas for fish; provide important habitats for wildlife (of the 414 wildlife species that occur in western Oregon and Washington, 359 use riparian or wetland areas during some seasons or parts



Beaver pond and wetlands along Multnomah Channel, Oregon.

Photo by Bruce Taylor.

of their life cycle, Appendix H); provide habitat for 35% of all rare and endangered animal species while only constituting about 5% of the nation's lands; provide recreation; and provide open space and aesthetic values.

There are a variety of types of wetlands, but they can be grouped into six general categories: swamps,

bogs, marshes, fens, wet meadows or prairies, and shallow water.³⁹ Swamps are dominated by shrubs or trees that are rooted in hydric soils. Willamette Valley examples are the bottomland hardwood forests that were once common on river and stream floodplains. Marshes are dominated by herbaceous plants, rooted in hydric soils, that emerge from the water. A Willamette Valley example is the cattail marshes often found around the edge of lakes, ponds, and old river oxbows. Bogs are dominated by mosses, sedges, ericaceous shrubs (blueberries, Labrador tea, cranberries), or evergreen trees rooted in deep peat. Examples are the floating bogs that surround many lakes in Alaska and taiga forests of Canada. Bogs are rare in the Willamette Valley. Fens are dominated by sedges and grasses rooted in shallow peat, often with considerable water movement through the peat. Examples are the extensive peatlands of northern Canada and Alaska. Fens do not occur in the Willamette Valley. Wet meadows are dominated by herbaceous plants rooted in occasionally flooded soils. Temporary flooding excludes establishment of terrestrial plants intolerant of saturated soils and swamp

plants that require more permanent flooding, but drier growing seasons produce plant communities adapted to both wet and drought. These wetlands can be easily overlooked if visited during dry periods. The wet prairies that once occurred on much of the Willamette Valley floor are examples of this type of wetland. Shallow water wetlands are dominated by truly aquatic plants growing in and covered by at least 10 inches of water. Examples include the open water of ponds, river oxbows, and borrow areas.

Historically, the Willamette Valley contained extensive wetlands, but as settlement occurred they were drained and cleared to make way for agriculture. Many of the wet prairies and bottomland riparian forests survived until the 1950s when flood control, irrigation systems, new farming techniques, and the grass seed market made it feasible to develop these areas more intensively. It is estimated that more than one million acres of wetland and riparian habitat have been lost from the Willamette Valley since 1850.² Virtually all remaining wetlands have been impacted by human activities and most are dominated by invasive, non-native plants.

Alterations to wetlands fall into three sometimes overlapping categories — biological, chemical, and physical.³⁷ In western Oregon biological alteration typically occurs through removal of natural vegetation and invasion by nonnative plants and animals. Chemical alteration usually comes in the form of nutrient loading from runoff of fertilizers and animal waste, or toxification from chemical runoff. The most destructive alteration of wetlands has been physical: by eliminating the topography and hydrology that supported the system through wetland drainage, construction of dams, diking, and dredging and channelization of rivers and streams.

Wetland restoration, as used in this guidebook, is rehabilitation of a degraded wetland or reestablishment of a wetland that has been altered. This may be nothing more than controlling overgrazing to allow reestablishment of native wetland plants, or it may be more complex, such as removing fill, reestablishing proper hydrology, reintroducing native species, and controlling exotic species. Wetland creation, on the other hand, is the construction of a wetland on a site that was not previously a wetland. Restoration projects, which improve existing conditions or rebuild conditions that once existed, are more likely to succeed than creation projects, which attempt to build a completely new system.

This guidebook is intended for landowners with limited resources or restoration experience who wish to restore wetlands with simple, minimally technical methods that have a high potential of success. Some landowners may wish to create wetlands on their property, but these projects typically

require sophisticated and expensive engineering and construction techniques that are beyond the scope of this guide.

Wetland restoration may require permits, depending on project size, location, and what is proposed (pond excavation, filling, recontouring, etc.). The Oregon Watershed Enhancement Board's publication, *A Guide to Oregon Permits Issued by State & Federal Agencies With a Focus on Permits for Watershed Restoration Activities*,³ or organizations listed in Appendix D, can assist with determining permit requirements. Permit requirements will be identified in the following sections where applicable.

The following recommendations come predominantly from four sources.^{37, 39, 41, 42} Those wishing to obtain additional information or delve more deeply into the subject of wetland restoration may wish to review these publications. One of the sources, the Washington State Department of Ecology's *Restoring Wetlands in Washington: A Guidebook for Wetland Restoration, Planning, and Implementation*,⁴² is of particular value as it pertains to wetland restoration in the Pacific Northwest.

WETLAND RESTORATION

Restoration follows a sequence of steps: project planning, site assessment, funding, restoration design and implementation, and management of restoration sites.⁴² For many simple restoration projects, project planning and assessment occurs during development of recommended conservation and management practices for the Wildlife Habitat Conservation and Management Program plan. Restoration techniques for shallow water, marsh, and stream channel associated wetlands are presented in this chapter. Restoration of wet prairie, riparian, and swamp or bottomland hardwood forest wetlands is discussed in following chapters.

PROJECT PLANNING.

Project planning starts with formation of goals and objectives for a site. To insure a successful project, the potential effects of the project on the landowner and adjacent landowners and residents should be considered. For the landowner, primary considerations are project costs, time requirements, amount of technical design and engineering, and sophistication and magnitude of construction. For adjacent landowners and residents, primary considerations include aesthetics of the project, off-site issues such as mosquitoes, odors, and flooding, increased access, and potential vandalism. Generally these issues are considered by the landowner and technical advisors during development of the Wildlife Habitat Conservation and Management Plan. Project goals and objectives are generally expressed in the habitat plan as "enhance or restore wetlands."

SITE ASSESSMENT.

The first step in wetland restoration is site analysis.⁴⁰

SIMPLE ASSESSMENT OF EXISTING OR DEGRADED SITES. On sites that are suspected to be existing or degraded wetlands, such as pastures, hay fields, depressions, and low areas along streams and drainages, this assessment may be nothing more than answering the following questions (Box 3, below).

BOX 3**ARE OR WERE THERE WETLANDS ON MY LAND?³⁸**

A yes answer to any of the following questions may indicate that the site is, or has been, a wetland

Yes No

- | | | |
|--------------------------|--------------------------|---|
| <input type="checkbox"/> | <input type="checkbox"/> | Are there natural drainage channels or swales? |
| <input type="checkbox"/> | <input type="checkbox"/> | Is the ground soggy underfoot in the spring? |
| <input type="checkbox"/> | <input type="checkbox"/> | Are there depressions where water pools for several consecutive days in the spring? |
| <input type="checkbox"/> | <input type="checkbox"/> | Do you avoid the area with heavy equipment for fear of getting bogged down? |
| <input type="checkbox"/> | <input type="checkbox"/> | Has the site been ditched to dry it out? |
| <input type="checkbox"/> | <input type="checkbox"/> | Are seeps or springs present? |
| <input type="checkbox"/> | <input type="checkbox"/> | Are there sediment deposits on fallen leaves? |
| <input type="checkbox"/> | <input type="checkbox"/> | Is the soil dark or light gray rather than brown or reddish brown? |
| <input type="checkbox"/> | <input type="checkbox"/> | Dig a shallow hole and remove a clump of soil. Are there rusty red mottles against a gray background? If you remove a live root from the clump surface, does it leave a rusty line? |
| <input type="checkbox"/> | <input type="checkbox"/> | Is there evidence of surface scour from running water? |
| <input type="checkbox"/> | <input type="checkbox"/> | Do you see many clumps of rushes (round stems), sedges (triangular stems), skunk cabbage, willows, or Oregon ash? |
| <input type="checkbox"/> | <input type="checkbox"/> | In forested areas, are there large hummocks, trees with fluted bases, and trees grown on nurse logs? |

Another simple site assessment is based on the vegetation at the site. Plants such as skunk cabbage, are "obligate" wetland species that are found only in wetlands. Their presence is an indication that an area is a wetland. Other plant species are often found in association with wetlands and can also be used as indicator species. The presence of these plants during the dry time of year can also be used to identify areas that are seasonal wetlands. Box 4 (below) is a list of some of the more common indicator plant species for wetlands in the Willamette Valley.

BOX 4**EXAMPLES OF WETLANDS TYPES AND TYPICAL VEGETATION****OPEN WATER**

Water Lily	Bladderwort
Pondweed	Watercress
Duckweed	

MARSH

Common cattail	Wapato
Hardstem bulrush	Slough sedge
Yellow iris	Bur-reed
Spike rush	Rice cutgrass
Reed canarygrass	Marsh speedwell
Water parsley	Water plantain

WET MEADOW

Creeping buttercup	Nodding beggarticks
Willow dock	American sloughgrass
Giant horsetail	Tufted hairgrass
Sedges	Soft rush
Gum-weed	Fragrant popcorn flower

SHRUB WETLANDS OR SWAMP

Pacific willow	Red-osier dogwood
Douglas' spirea	

FORESTED WETLANDS OR SWAMP — OVERSTORY

Red alder	Willows
Oregon ash	Black cottonwood

FORESTED WETLANDS OR SWAMP — UNDERSTORY

Lady fern	Aquatic sedge
Water parsley	Widfruit sedge
Slough sedge	Baltic rush
Skunk cabbage	Large-leaf aven
Douglas' spirea	

If these simple assessments indicate that the project site is a wetland, go to Project Site Level Assessment (below) for additional site assessment procedures.

Assessment of Disturbed Sites. In the case of disturbed sites, site analysis may be more complicated. Preexisting conditions may not be known and site hydrology, soils, and vegetation may have been modified by draining, filling, and removal of the original vegetation. This precludes identification and delineation of former wetlands through application of the criteria outlined above. Other tools must be used to determine the potential of these sites for wetland restoration.

Landscape Level Assessment. A landscape-level assessment of the project site's setting will provide important information. If it is in an area classified as a wetland, the system, subsystem, class, subclass, and modifiers (see reference³⁵ for complete discussion of this classification system) are important in determining what type of wetlands should be restored. Sources of information to assist with this determination include any available historic aerial photography, US Fish and Wildlife Service (USFWS) National Wetland Inventory maps, and U.S. Department of Agriculture, Natural Resource Conservation Service (NRCS) Wetland Inventory maps and Soil Survey reports.

The most informative of these sources are probably the USFWS wetland inventory maps. While these maps may be complicated and difficult to interpret, they provide valuable information about whether or not the project area occurs within an area classified as wetlands and, if so, what type of wetland. The maps also identify wetlands' hydrology (subsystem), substrate (class), dominant vegetation (subclass), and special soil characteristics (modifiers). Types of wetlands include river or braided stream channel (Riverine system); topographic depression or lake (Lacustrine system); and marshes, swamps, and wet prairies (Palustrine system). The subsystem indicates if the area was a channel, whether waterflow was seasonal or year-round, and what the gradient and water velocities were. If the area was a depression or lake, the subsystem indicates if it had deep, open water or shallow water. The class describes the physiography and composition of the substrate and types of substrate (cobble-gravel, sand, mud, organic) of the area. The subclass indicates the dominant vegetation type, its seasonal persistence, and whether it is deciduous, evergreen, or dead. The class information is necessary for wetland design: will the substrate facilitate ponding of water and support creation of ponds and ephemeral pools? Or will it allow water to flow through the system and be more appropriate for bottomland hardwood forests? The subclass information suggests what plant species are appropriate for revegetation of reconstructed wetlands. The last pieces of information available on the wetland maps are the soil modifiers; these indicate periodicity

and extend of flooding, water chemistry and pH, and any special soil characteristics.

The NRCS Wetland Inventory maps and Soil Survey reports are useful as a supplement to the USFWS wetland inventory maps. The inventory maps are a second source of classification for a site and, in conjunction with the soil survey reports, indicate whether or not hydric soils are present and, if so, which ones. The soil survey reports provide information about soil characteristics, including permeability and their ability to support various plant associations. USFWS wetland inventory maps for the Willamette Valley can be obtained from the Oregon Division of State Lands at 775 Summer St. N.E., Suite 100, Salem, Oregon 97301-1279 or by calling (503) 378-3805. Maps can also be ordered on line at http://statelands.dsl.state.or.us/wetland_nwi.htm

NRCS Soil Survey reports and accompanying maps can be obtained from the local NRCS office (see Appendix D) or on line at: <http://www.or.nrcs.usda.gov/soil/oregon>

An alternative to the USFWS wetland inventory maps and NRCS wetland inventory and soils maps and reports is the Oregon Division of State Land's hydrogeomorphic-based assessment of Oregon wetland and riparian sites.⁴³ This system classifies wetland and riparian sites in Oregon based on their hydrogeomorphic features and functions. It presents detailed wetland classifications for the physiographic provinces of Oregon, including one specifically for the Willamette Valley. This guidebook does not use this classification system, but it can be obtained in the form of a three-volume report from the Oregon Division of State Lands (see Appendix D).

Project Site Level Assessment. If the landscape-level assessment indicates a likelihood that wetlands once occurred at the site or if the simple site assessment confirms that wetlands are present, then a more in-depth site assessment should be completed. This typically includes assessments of the hydrology, topography and soils, water quality, wetland vegetation association, and a review of historic conditions if available.⁴⁰ In addition, it may include examination of nearby wetlands and restoration projects to get an idea of what may have occurred on the site and what techniques worked in restoring neighboring sites.

Hydrology. Establishing and maintaining appropriate hydrology is the most critical factor in wetland restoration. The quantity and timing of water entering and leaving the site are paramount to a successful project. All water sources, such as springs, groundwater, floodwater, rain or snowmelt, irrigation overflows, and any other surface and subsurface sources of water, and their flow rates should be identified.

Hydroperiod (the seasonality of water flow into the system), duration of inundation, and water depth are major influences on what type of vegetation will grow in a wetland. This information may be available from the local Soil and Water Conservation District, local Natural Resource Conservation Service office (Appendix D) or neighbors. If measurement is necessary, hydrology stakes and shallow observation wells may be used. Wells are placed in suspected wetland areas and adjacent upland areas to define surface and groundwater conditions. They typically consist of 4-inch diameter PVC pipe inserted 48-96 inches with a backfill of gravel or other permeable material. Water levels in these wells are periodically observed (recommended weekly) during the analysis to define the depth of ponding and groundwater level. Ponding levels and areas with differing groundwater levels are marked with the hydrology stakes. The longer the monitoring, the more likely seasonal variations will be observed. A private wetland consultant or hydrologist from the NRCS or Soil and Water Conservation District should be contacted for assistance with this analysis.

Water Quality. Water purification is a natural function of wetlands. As water passes through a wetland system a number of organic and inorganic processes occur. Particulate matter such as suspended soil and associated nutrients and pollutants settle out or are filtered out by fibrous root systems of plants. Dissolved nutrients such as phosphorus and nitrogen are taken up by biological organisms or lost to the atmosphere. Heavy metals are absorbed or settle out of the water, and exposure to light and the atmosphere breaks down organic pesticides and kills disease-producing organisms. These functions have led to the use of natural and constructed wetlands to treat wastewater from industry, agriculture and domestic sources.⁵⁰

Excessive pollution can damage a wetland. High sediment loads smother aquatic vegetation, animals, and desirable bacteria, and increased water temperatures trigger release of pollutants from sediment and eutrophication. High levels of heavy metals are toxic to plants and animals or prevent nutrient uptake by plants, and excessive pesticide levels damage or kill wetland plants and animals. In the Willamette Valley water pollution is often associated with livestock operations or intensive farming where heavy fertilizer and pesticide use occurs. High concentrations of animal waste and chemical fertilizers can generally be tolerated and processed by a wetland, but pesticides can only be tolerated at lower concentrations.

A recent analysis of dissolved pesticides in small streams in the Willamette Valley identified 36 different pesticides (29 herbicides and 7 insecticides).⁵³ Those most frequently detected were the herbicides atrazine, desethylatrazine, simazine, metolachlor, and diuron. Atrazine, a

restricted-use pesticide, is considered to be slightly toxic to aquatic animals and biodegrades quickly in water.⁵⁴ Desethylatrazine is a degraded form of atrazine. Simazine is considered to be slightly toxic to aquatic animals, but wildlife or livestock grazing on treated vegetation may be poisoned. It is moderately persistent in soils and is decomposed by microbial activity. Metolachlor is considered to be only slightly toxic to terrestrial animals but is moderately toxic to aquatic animals. It is moderately persistent in soils and highly persistent in water. It is decomposed by microbial activity.⁵⁴ Diuron is considered slightly toxic to terrestrial animals but moderately to highly toxic to aquatic animals, particularly invertebrates. It is highly persistent in soils and water and is decomposed by microbial activity.⁵⁴ Atrazine, desethylatrazine, metolachlor, and diuron were most common in the southern valley in association with grass seed crops. Atrazine was also found in association with Christmas tree plantations. Simazine was associated with row-crops and berries and occurred more frequently in northern valley streams. Concentrations of these pesticides were highest in the early spring and late fall when run-off from fields was highest.

If the project area is immediately downstream from an area where pesticides are known to be used, it may be appropriate to test water quality. Tests should be made during early spring, late fall, or during application. If pesticide concentrations are high, their toxicity and persistence should be identified. This can be done by checking the Extension Toxicology Network Pesticide Information Profiles at Oregon State University. Or online at: <http://ace.ace.orst.edu/info/extoxnet/pips/ghindex.html>. If the identified chemicals are toxic to aquatic life, a catchment/settling basin may be appropriate at the beginning or head of the wetland. Designs can be obtained from the local NRCS, Soil and Water Conservation District or an NRCS technical note entitled "Nutrient and Sediment Control System,"⁵⁵ which is available at: <http://www.sedlab.olemiss.edu/projects/rodrigue/noteN4.pdf>

Topography. Proper water depths and duration are important in establishing and maintaining wetlands. Contour and slope of the project site will determine runoff rates, ponding, and water depth. Gentle slopes don't drain as rapidly or extensively as steeper ones, which is generally beneficial to most wetland vegetation. However, gentle slopes are more susceptible to ponding, which can be problematic for riparian woodland species unless the soils are relatively permeable. In small projects, contour and slope can generally be determined by visual estimates or with a homemade device consisting of two stakes or dowels, 8-10 feet of twine, and a line-level. The object is to mark similar elevations around the project site with stakes to illustrate contour and slope. One stake, the anchor stake, is driven into the ground.

The depth this stake is driven into the ground is not important but should be sufficient to allow pulling the twine taut against it. Consistency in the depth that the anchor stake is driven into the ground for each measurement is important, so the depth should be marked on the anchor stake. The twine is tied to the second stake at the same distance above ground as it is on the anchor stake. The second stake is not driven into the ground. The two stakes are separated until the twine becomes taut and the line level is attached midway between them. The second stake is moved up or down-slope until the level indicates that the line is level. This point is then marked with a stake or similar marker. This process is repeated until the elevation has been marked throughout the project site. The process is repeated at different elevations until the slope and contours of the site are defined. The distance between elevations will depend on the size of the project and steepness of the slope.

For larger projects, the use of a line-level in determining slope and contour is impractical. In these situations a transit or laser level should be used to shoot elevations. If the user of this guidebook is not familiar with these devices or their use, a land surveyor should be hired to shoot contours.

Soils. Soil analysis is an important step in defining wetland restoration opportunities and limitations. This analysis will identify the presence or absence of hydric soils and limitations to construction such as permeability of soils or soil chemistry. Wetland restoration is not feasible in highly permeable soils that will not hold water or soils with a high salinity or abnormal pH (highly acidic or high mineral content). The best source of soil information is from NRCS soil series maps. As previously mentioned, these can be obtained from the local NRCS office (see Appendix D) or on line at: <http://www.or.nrcs.usda.gov/soil/oregon>. This website offers the soils survey reports for Oregon, including interactive maps, legends, text, and tables as well as an introductory discussion of hydric soils and list of hydric soils for Oregon soil survey areas. If soil series maps are not detailed enough, on-site surveys may be necessary. However, these require an understanding of soils and classification methods and are better left to NRCS field personnel or private consultants.

Soil texture and permeability strongly influence the wetland type.⁴⁰ Fine-textured, less permeable soils typically support a wetter vegetation association and larger wetland than do coarse-textured, more permeable soils. More permeable and well-oxygenated soils will support woodlands in addition to, or instead of, marshes. As a rule of thumb, seasonal marshes generally require a surface horizon of 4-18 inches of soil with some water holding capacity. When root zone saturation is infrequent, a deeper horizon is needed. Seasonal marshes may be established even in extremely permeable soils if the water levels are periodically within

6-18 inches of the surface for 2-3 weeks of every month during the growing season.

Wet meadows typically occur on clay or clay loam soil that is saturated for 4-8 weeks in an average year. Inundation may be infrequent but long-standing when it does occur due to the dense nature of the soil.

Riparian woodlands and bottomland hardwood forests have a wide tolerance for soil types but wetter vegetation associations are less dependant upon the soil type than are drier vegetation associations. Species growing on low terraces where water levels are shallow may grow on thin cobble. However, woodland species growing on mid- and higher-level terraces, where water levels may be much lower, require a greater depth of permeable soil.

Vegetation Associations. Effective wetland enhancement or restoration hinges upon establishment of the appropriate plant community. On degraded sites, many of the appropriate plant species may already be present. Successful plant community restoration in these situations is often nothing more than protecting these plants and enhancing their growth. In situations where additional plant species need to be established, or where reconstruction of wetlands is planned, plant communities on nearby wetlands may be used as a reference. The advice of a wetland ecologist or specialist from one of the organizations in Appendix D may also be helpful.

The distribution and abundance of exotic invasive species such as reed canary grass, purple loosestrife, Eurasian milfoil, common reed, and creeping Canada thistle should also be considered. If these species are present at or near the site, plans for controlling them and other problem species, such as the native cattail, should be developed. The Oregon Department of Agriculture's Noxious Weed Control Program (Appendix D) can recommend control programs.

FUNDING

A number of state and federal funding sources are available to assist landowners with habitat management restoration projects. Some of these have very limited funding, while other are typically under-subscribed. Some are competitive and some are not. See Appendix C for a listing of funding sources.

RESTORATION DESIGN AND IMPLEMENTATION

Although a variety of steps can be taken to manage for wetlands, they all fall into three basic categories: those intended to *maintain existing wetlands*, those intended to

enhance existing or degraded wetlands, and those intended to *recreate historic wetlands*. Restoration steps, which are generally identified as Conservation and Management Practices in ODFW's Wildlife Habitat Conservation and Management Program plan, can be as sophisticated as designing and building major water control structures and dikes, or as simple as avoiding "swampy" areas when they are wet. Each project area's potential and the goals of the landowner will determine what restoration or management actions are appropriate.

WATER SUPPLY

Water management, according to the *Natural Resource Conservation Service's Engineering Field Handbook*,⁴⁹ "is a broad term used to describe application of water for irrigation, control of excess ponding, and the control of excess soil moisture." In the Willamette Valley the last two applications have been used over the past half-century to increase farm production through wetland reclamation and drainage of existing fields to facilitate more intensive use. Wetland restoration starts with reversing these applications and insuring an adequate water supply.

Although there are five general types of drainage systems⁴⁹ (surface, subsurface, interception, water table management, and pumping), only three of these can be reasonably addressed by most landowners without extensive hydrological investigations and engineered projects. These are subsurface and surface drainage systems and interception systems.

Subsurface drainage is accomplished with drain fields that remove or control free water from the soil surface and below the surface of the ground. Concrete pipe, thermoplastic pipe, and clay pipe have been used in these drainage systems. Pipes are typically laid out in random, parallel, or herringbone patterns, depending upon the topography and sources of excess water. A random drainage system is used where the topography is undulating and has isolated wet areas. The main drain is generally placed in the lowest natural depressions and smaller lateral drains branch off to tap the wet areas. Parallel drainage systems consist of laterals that are perpendicular to the main drain. This design provides intensive drainage of an area and is most commonly used in tilled fields on the valley floor. The herringbone system consists of laterals that enter the main drain at an angle and is often used in small or irregular areas.

Blocking Subsurface Drainage Systems. The water supply to wetlands drained by drain fields can usually be restored by destroying the drainage system. Culverts can be removed or plugged with dirt. Drain fields can generally be blocked by locating their outlet and blocking or destroying it. If the drainfield is extensive or the slope steep, it may have

to be blocked in several places. Since no two drainfields are alike, there is no "cookbook" method of blocking or destroying them. If the field is older and clay drain pipe was used, the pipe can be crushed. If the drain field was installed more recently, plastic pipe was likely used. These drains can persist for many years and benign neglect alone will not eliminate them. Sections of the drain field must be located and removed. Before blocking or removing a culvert or drainfield, be sure that the resulting higher water table will not cause damage or problems to structures such as septic tank drainfields, basements, or neighbors. Contact the local Soil and Water Conservation District or Natural Resource Conservation Service office (Appendix D) for advice and assistance if you are not sure.

Surface drainage is most often accomplished with open ditches, dikes, and embankments. Drainage ditch systems are often laid out in random, parallel, and herringbone patterns similar to subsurface systems. Dikes and embankments are frequently used either alone or in conjunction with ditches to intercept and divert surface runoff away from a wetland.

Blocking Surface Drainage Systems. The water supply to wetlands drained by ditches, dikes, and embankments can be restored by destroying the drainage system or breaching the diversion structure. If drainage ditches are shallow and little channel erosion or incision has occurred, restoration may be nothing more than simply blocking or removing the ditches. Unfortunately, eroded and incised channels are common in unmaintained or abandoned drainage systems in the Valley. Restoration of these systems can require more complicated treatments.

INSTALLATION OF SMALL DIKES, LEVEES, AND EMBANKMENTS^{44, 45, 94, 114}

Drainage ditches or incised channels can be blocked with check dams to slow runoff and back water up into the wetland. Check-dams can be constructed of straw wattles and excelsior logs, bales of straw, notched logs, or wood, rock and earth. Generally, these structures are perpendicular to the flow of water. To minimize erosion problems during construction and facilitate installation, check-dams should be installed during the dry season when flows are minimal. The following table will assist with selection of the appropriate check-dam.

Straw wattles and excelsior logs are straw or wood-fiber cores wrapped with synthetic netting. In surface, low-flow situations, they tend to pond water and catch sediment. These structures are available in many diameters to meet various situations, relatively inexpensive, and easy to use. Disadvantages are their limitation to only low-flow situations, and need for periodic maintenance. They can be helpful in establishing permanent vegetation in a channel. Straw wattles and excelsior logs can be partially buried in a

BOX 5

SELECTING A CHECK-DAM TYPE⁹⁴

Type of Check-dam	Erosion Activity*	Optimum Channel Size	Soil Particle Size	Durability	Special Site Conditions	Common Reasons for Failure
Straw Wattles	low	1-2 ft. deep, up to 6 ft. wide	fine to coarse	2-5 yrs.	use with woody cuttings for revegetation	Not secured properly; erosion too active, no follow-up maintenance
Strawbale	low	up to 3 ft. deep, 3-6 ft. wide	fine to coarse	2-3 yrs.	Use only in areas that can be seeded or where natural vegetation will occur quickly	Bales not keyed into banks and bottom securely; animal damage; erosion too active; no follow-up maintenance
Rock	low to high	up to 3 ft. deep and 10 ft. wide	fine to coarse	indefinite	Rock on site or accessible to truck or loader	Rock too small; not securely keyed into banks and bottom; spillway too small
Log	low to moderate	up to 3 ft. deep and 4 ft. wide	coarse	5-20 yrs. depending on type of wood	Works best in gravelly soils with much organic matter such as leaves and twigs	Not securely keyed to banks and bottom; energy dissipater does not extend far enough downstream; if multiple logs used, gaps between them too large; spillway too small
Board	low to high	2-5 ft. deep, 2-10 ft wide	fine to coarse	up to 20 yrs. depending on type of wood used		Not securely keyed to banks and bottom; poor quality wood used; energy dissipater inadequate; erosion too active, spillway too small
Brush and rock dams	low	up to 3 ft. deep, up to 4 ft. wide	fine to coarse	2-3 yrs., indefinite if live stakes used.	Use only in seasonal channels where minor flooding/flows are present	Not anchored securely; rock too small; live cuttings planted upside down; insufficient size; too dry in summer & plants die
Post and brush dams	low to moderate	up to 3 ft. deep, up to 4 ft. wide	fine to coarse	2-3 yrs., indefinite if live stakes used.		Not anchored securely; live cuttings planted upside down; insufficient size; too dry in summer & plants die
Dirt berm	low	up to 18 in. deep, indefinite width	fine	indefinite if vegetated	Use only in seasonal channels where minor flooding/flows are present	Flow too great; erosion too active, not revegetated, seasonally too dry to support vegetation

***Low:** Headcut is shallow (<3 ft.) and does not grow noticeably during heavy rainfall. Banks are gently sloped and mostly covered with grass, tree roots or other vegetation.

Moderate: Headcut is shallow, but expands noticeably during winter storms. Banks are gently sloped and mostly covered with vegetation with occasional steep areas of raw, exposed soil.

High: Headcut is more than 3 ft. deep and moves rapidly uphill during heavy rainfall. Banks are steep with little vegetation.

channel to create mini-dams. To prevent them from shifting they should be anchored with wooden stakes. These structures are recommended for retarding flow in small drainage ditches and surface flow out of marshes and shallow water bodies. They should not be used in areas of high flow or where seasonal high flows are expected.

Straw bale dams are inexpensive and easy to work with. They also act as sediment traps and rapidly become overgrown with vegetation. Disadvantages are their rapid decomposition rate and lack of suitability for steeper channels with high water velocity (should not be used in channels deeper than 3 feet). Availability may also be an issue. To prevent the introduction and spread of exotic grasses, bales should be of native grass straw. Use of non-native grass straw bales will introduce exotic grasses into the wetland that will be difficult to control or eradicate. Availability of native grass straw bales is generally quite limited so an adequate supply should be located or ordered before starting a project. Possible sources include the U.S. Bureau of Land Management (see Appendix F for contacts), and the Oregon Department of Transportation (see Appendix D). Some of the nurseries in Appendix A may also be able to help.

To install a straw bale check-dam, first smooth the bottom of the channel so that the bale will seat properly, minimizing the potential for water to flow under and undercut the structure. If the banks are relatively steep, they should be notched so that the bale is laterally keyed into them on both sides. Once the bale is in place, excess space around the ends of the bale should be back-filled and tamped to minimize the potential for erosion. Rocks can be stacked on the upstream side of the bale where it is keyed into the bank to reinforce it. If the channel is too wide to block with one bale, additional bales can be placed end-to-end across the channel. They should be placed together as tightly as possible to avoid gaps. If gaps are unavoidable, chink them with small rock. Anchor bales in place with steel fence posts driven through them into the bottom of the channel.

In wide, shallow channels, several bales may be placed together end-to-end as discussed previously. The center bale is used as a spillway and the side bales should be rotated slightly uphill to create a horseshoe shaped structure. This creates a bowl that will

catch sediment. As above, bales should be placed together tightly and gaps chinked. The crest of the spillway bale must be below the bottom of the last side bale to insure that the flow of water does not go around the end of the dam. Anchor bales in place with steel fence posts driven through them into the bottom of the channel.

Notched-log dams (Fig. 3) can also be used to retard drainage. The advantage of logs, relative to straw bales, is their longevity. Their disadvantage is difficulty of handling. They should not be used in channels deeper than three feet. Design features such as log size, lateral keying, spillway size and height, and good contact with the streambed are important considerations in constructing log dams. A log must be long enough to span the channel and extend into the bank 2-3 feet on each end, and of sufficient diameter to allow notching of a spillway and still provide adequate spillway elevation to back water up to the desired depth. If available, an on-site tree can be used to reduce handling costs. To insure a good fit and seal between the log and channel bed that will prevent under-cutting, the log should be laid in a trench across the bottom of the channel. The banks are notched to allow the log to extend into them 2-3 feet on each side. The excess space in these notches is back-filled and packed after log placement. In addition, to protect them and minimize the possibility of erosion, the upstream side of the notches should be reinforced with rock if possible. After the log is in place, a spillway is notched into it with a chainsaw. The spillway should be wide enough to accommodate high flows during the wet season. Otherwise, water is likely to back up and bypass the dam, creating a new erosion problem and

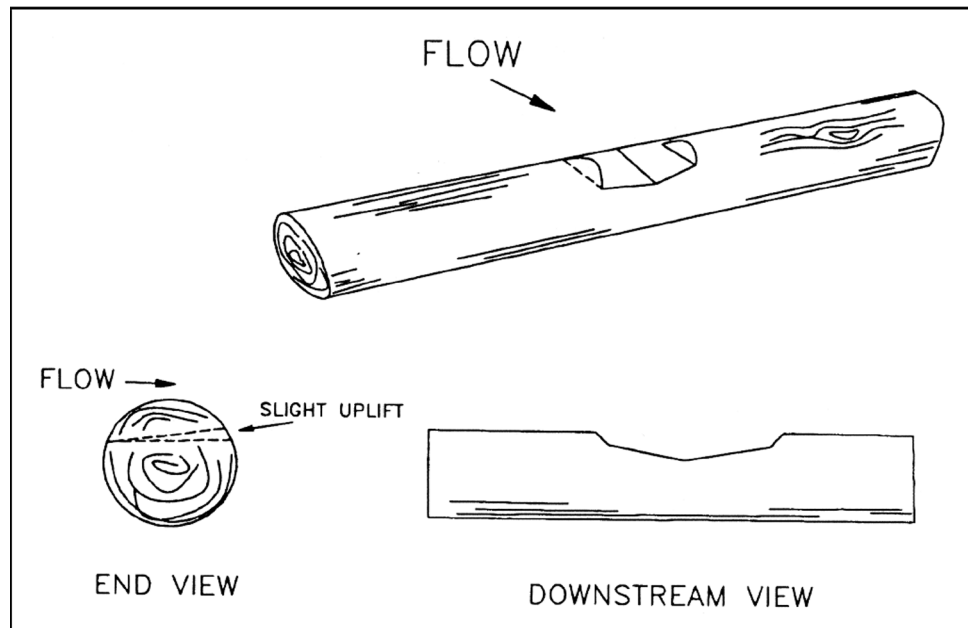

Figure 3. Notched log weir.

Image courtesy of the California Department of Fish and Game.

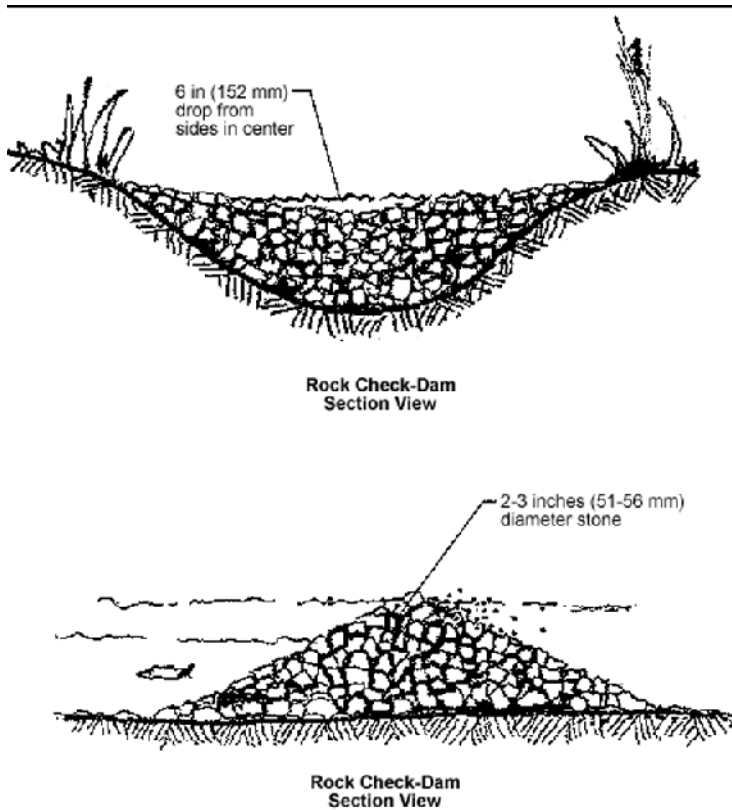

Figure 4. Rock weir.
Image courtesy of the California Department of Fish and Game.

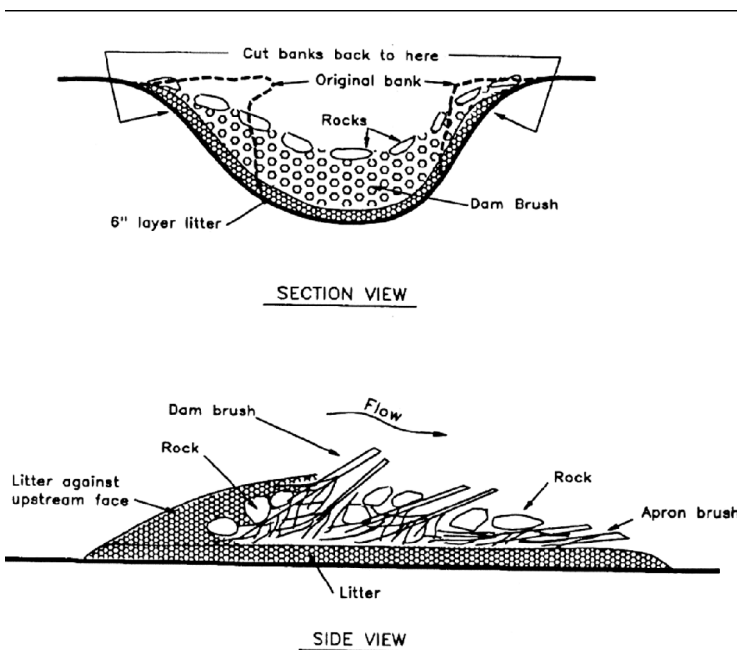

Figure 5. Brush and rock dam.
Image courtesy of the California Department of Fish and Game.

possibly blowout of the structure. The depth of the spillway is important as it will determine the depth of the water backed up behind the check-dam. Landowners not familiar with construction of log dams should seek the assistance of their local Soil and Water Conservation District or Natural Resource Conservation Service representative (Appendix D).

Rock check-dams (Fig. 4) can be constructed with large aggregate with a minimum stone diameter of 2-3 inches. Advantages of rock dams are ease of installation and permanency. Disadvantages include having to purchase the material and, in wet areas, getting stone to the construction site. Rock dams should not exceed 3 feet in height and should have an approximate 6-inch drop from sides to center. Some designs call for keying the dam 6 inches into the bottom of the channel and a 9-inch drop from sides to center of the dam.⁴⁴ These structures are intended to slow runoff and provide a sediment trap. Establishment of vegetation can be encouraged by placing soil on the surface of the structure.

Brush and rock dams (Fig. 5) are suitable for small ditches and channels. Place 6-inch layer of litter along bottom and sides. Beginning at the downstream end of the ditch or channel, place an 8-inch thick apron layer of brush on top of the litter. Butt-ends must point downstream. Near the upstream end of the brush apron layer, stack a row of rocks on top of the brush layer about one foot high and perpendicular to the channel. When available, flat rocks are the most stable and preferable. Place a four-foot layer of brush parallel to the channel, butt-ends downstream and extending just downstream of the rock dam. Place another row of rocks at least one foot high across the middle of the brush layer. Walk on the brush to compact it while adding rocks. Repeat the layering of rock and brush to the desired height. Weight the last layer of brush with a row of rocks to hold it in place. Cover the upstream face of the dam with soil. Mulch the soil layer with a 4-inch layer of litter and seed or plant. If area is likely to stay wet, willow or cottonwood sticks may be used.

Post and brush dams (Fig. 6 next page) are suitable for use within large, moderate- to high-activity seasonal ditches and streams. Set metal "T" posts or wooden posts 2-4 inches in diameter across the streambed or ditch on 2-foot centers. They should be buried or driven a minimum of 18 inches into the ground. Live willow poles may be used if the soil is saturated year-round. Layer small-diameter brush parallel to the channel to act as a filter and soil erosion blanket. Each layer should be approximately 6 inches thick. The butt-ends should extend beyond the posts at least 6 inches in an upstream direction.

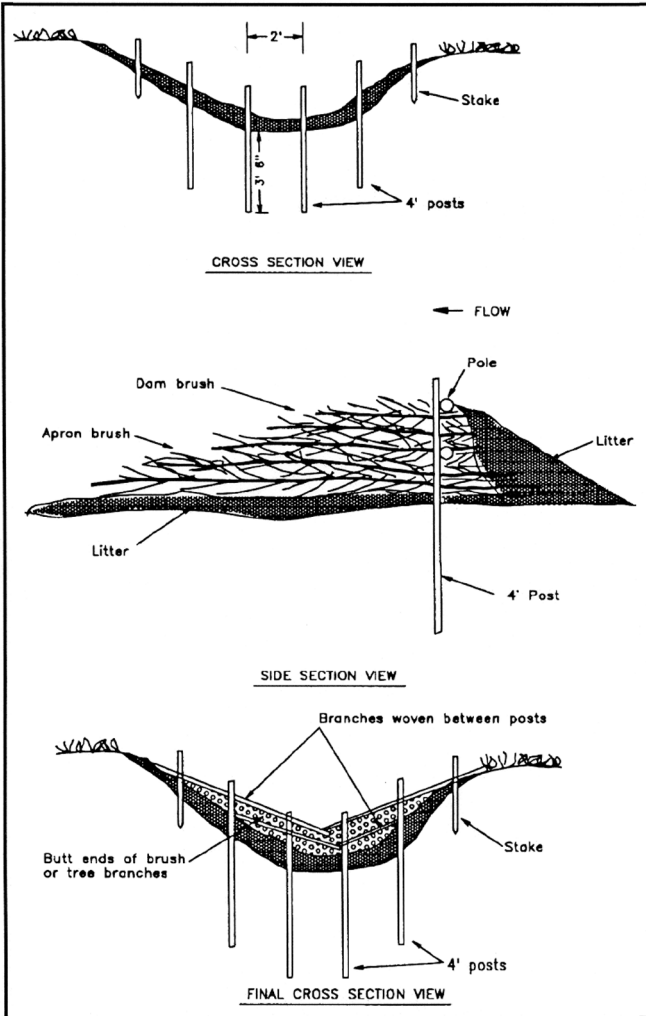

Figure 6. Post and brush dam.

Image courtesy of the California Department of Fish and Game.

Weave brush material through the posts at least one foot thick and continue adding material to the top of the posts. Attach branches or boards across the posts using rope or string to hold the brush down firmly. Compact each layer of branches to ensure that no gaps are present in the dam. At completion, the brush should be layered to the tops of the banks while leaving the middle section slightly lower to form a channel for flow. Seed and mulch any disturbed areas after completion.

Wooden check-dams (Fig. 7) and dirt berms are the least desirable methods of retarding wetland drainage. Both have flow rate and longevity limitations that make them impractical for most situations. Wooden check-dams can be used in small (3 feet or less deep and up to 10 feet wide), low-flow channels where a temporary reduction in runoff is desired.⁴⁵ They are economical and easy to install but cannot handle moderate to high flows and rot out quickly. To construct a wooden dam,⁹⁴ cut a keyway or trench into bottom of

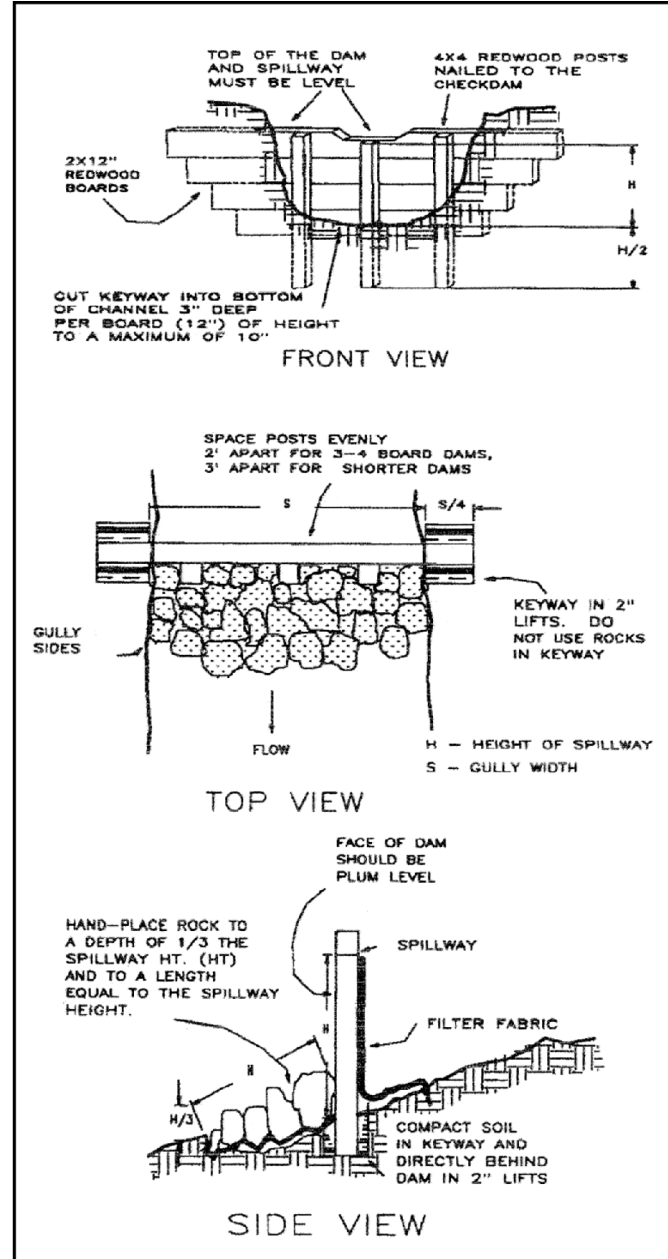

Figure 7. Redwood check-dam.

Image courtesy of the California Department of Fish and Game.

channel at a depth of 3 inches per board used in dam, with a maximum depth of 10 inches. Use heavy planks, such as 2 inch x 12 inch, to build the dam. Do not use treated lumber, as the chemicals used for treatment are toxic to plants and animals. Sink 4 inch x 4-inch posts 2-3 feet deep on the downstream side of the structure to nail planks to. Space posts 2 feet apart for dams with three or four boards and 3 feet apart for shorter dams. Cut an adequate spillway notch to accommodate high flows (leave 8-inch minimum distance from notch to bank) and low flows (approximately 4 inches deep and 6 inches wide). Place energy-dissipating materials such as rock, brush, or wood debris below the spillway.

Dirt berm dams (see photo below) are appropriate only in situations where flow is seasonal and low, such as surface runoff through swales and low areas. Without some type of spillway erosion control, such as vegetation or erosion control blankets, these structures have a very high likelihood of erosion and failure. They should not exceed 18 inches in height. Berms can be reinforced by placing rock on their surface to slow water velocities and protect them from erosion. They should be constructed as early in the season as possible so that vegetation can become established before winter storms. Native grass and forb species appropriate for revegetating dirt berms include smooth brome, slender wheatgrass, redtop, creeping fescue, red fescue, bluejoint, tufted hairgrass, Wood's strawberry, and slender cinquefoil.

BREACHING WATER-CONTAINING AND WATER CONTROL STRUCTURES.

Interception systems are typically dikes, levees, or berms constructed to divert water away from a wetland so that the area can be developed. These structures can vary in size from the large dikes and levees used to rechannel major rivers, such as those found along much of the Mississippi River, to small structures used to divert runoff from fields and pastures. Destruction or breaching of larger interception



Figure 8. A low dirt berm reinforced with rock. Notice willow cuttings in place upstream of the berm. *Photo by Rick Barney, NRCS.*

structures is beyond the scope of this guide. However, breaching of small structures along ditches, streams, and fields is often feasible and relatively simple. Before any interception system is breached, impacts to the surrounding area and neighbors should be fully assessed. Defeating dikes

and levees may not only cause flooding of an area but can also lower the water table and de-water other areas. If the results of breaching an interception system are not clear, it is advisable to obtain the advice of a hydrologist from the local soil and water conservation district, Natural Resource Conservation Service or local watershed council (see Appendix C).

Interception systems can be defeated several ways. They can be completely removed, breached with ditching or trenches, or modified with flow control structures. Each of these has advantages and disadvantages that a landowner should consider before starting the project. Complete removal, if done correctly, will require the least long-term maintenance. However, since removal of even the smallest berms and levees requires considerable soil removal and relocation, heavy equipment, and revegetation, costs can be substantial. In many cases, only a portion of a dike or levee needs to be removed. This reduces costs, time, and effort, plus the remaining portions of the structures will provide topographic relief and increase habitat diversity. Cutting through dikes and levees with ditches or trenches is usually fairly easy but can lead to erosion and incised channel problems. Unless an engineered spillway that will not erode is

installed to maintain partial function of the interception system, dikes and levees should be breached at the lowest point.

The third method of compromising a flow interception system, installing a flow control structure (see Water Control Structures section, next page), is probably the most desirable. Installation of a flow control structure such as a riser provides a means of controlling the flow of water into a wetland and allows management of water levels on both sides of the structure. The major disadvantage to this method is the need for minor engineering and design plus periodic maintenance. Contact the local county extension service, soil and water conservation district, or Natural Resource Conservation Service for advice on the feasibility of a water control structure, engineering and design, and source of materials.

Prefabricated water control structures are readily available and can usually be obtained locally.

Water Control Structures. In addition to the flow control structures discussed above, large dirt berms with some

type of water discharge structure (see NRCS Engineering field handbook, reference 49) can be used to block larger channels or to construct ponds with shallow water edges. These structures require proper planning, design, and construction with heavy equipment. Both the U.S. Fish and Wildlife Service⁴⁶ and Natural Resource Conservation Service⁴⁷ have published bulletins on the proper construction of farm ponds. Be aware, however, that these bulletins recommend deep ponds with limited shallow areas so that emergent vegetation will not become a problem. While some deep water is desirable, extensive shallow areas are needed to restore wetlands. Assistance with design and placement of earth dams can be obtained from the local Soil and Water Conservation District or Natural Resource Conservation Service representative (Appendix D). However, because faulty construction has resulted in the loss of many dams, unless the landowner is familiar with designing and constructing earth dams and berms, their construction should be left to experienced contractors.

Permits. Work in a wetland may require several permits. Removal or placement of material in wetlands that are isolated from streams or rivers requires a permit from the Oregon Division of State Lands if more than 50 cubic yards of material are involved. Projects that may not exceed this limit in any one year but that cumulatively exceed 50 cubic yards of material over multiple years do require a permit. Many small restoration projects do not exceed the 50 cubic-yard limit, but damming of larger channels or construction of ponds often does. Removal or placement of material in a wetland that drains into a stream or river generally requires a permit from the U.S. Army Corps of Engineers, regardless of the amount. Local jurisdictions may also require permits. For assistance in determining which of these permits are required, visit the Oregon Division of State Lands website at: <http://statelands.dsl.state.or.us/wetlandsintro.htm> or contact your local Soil and Water Conservation District (Appendix D).

The removal or fill of any material, regardless of the number of cubic yards affected, in a stream designated as essential salmon habitat requires a permit from the Oregon Division of State Lands. The removal or fill of any material from the bed and banks of scenic waterways, regardless of the number of cubic yards affected, also requires a permit from DSL. To determine if your project site includes essential salmon habitat or is part of a scenic waterway, contact DSL (Appendix D) or go to their on-line assistance page at: <http://www.oregonstatelands.res/r-fintro.htm> and click on "Essential salmonid habitat areas" for salmon habitat maps, or "State Scenic Waterways" for a list of scenic waterways.

Construction of ponds and water impoundments associated with wetland restoration may require a permit from the

Oregon Water Resources Department (OWRD). Contact the OWRD (Appendix D) before starting a wetland restoration projects to determine permit requirements.

Remember, all permits are required before work begins.

CONTROL OF UNWANTED VEGETATION⁴⁰

Many remnant or former wetlands in the Willamette Valley have been severely infested by invasive vegetation. This can be dealt with by manual or chemical means. Manual controls include hand removal of entire plants or cutting above ground. Chemical control is with herbicides.

Hand removal is labor intensive and best suited for small areas, ecologically sensitive areas, or woody plants. The advantages of hand removal are low impact to the entire project area and less of the type of disturbance that promotes weed establishment and growth. Cutting can include hand-pruning or chopping, weed whips, and tractor-driven or floating mowers. The type of manual control method will depend on the type and extent of weeds and the project design.

Plants vary in their response to cutting. Cattails generally decrease when cut, especially if cut annually for several years. Marsh smartweed, on the other hand, tolerates cutting and sometimes is even stimulated by it. Cutting of plants with rhizomes is often effective because they are dependant upon oxygen being supplied to the rhizomes by the above-ground foliage. If the leaves are cut and the plant remains inundated, the plant will die. An effective strategy is to cut the foliage as close to the ground as possible in the fall or winter if accessible. This should be repeated for 2-3 consecutive years.

Chemical controls are generally the least expensive means of controlling or eliminating weedy species and are often effective when used in conjunction with manual controls. However, there are a number of drawbacks to using herbicides. Few herbicides are licensed for use in aquatic or wetland environments, and their application may require a licensed technician. They may have lethal and sub-lethal effects on non-target animals and plants, some persist in the soil, and aquatic application can retard decomposition of organic mater.

To minimize the potential negative impacts of using herbicides, use only where necessary, treat the smallest area possible, apply when the hazards to wildlife are minimal, and follow the manufacturer's instructions. The safest herbicides are organophosphates carbamates because they persist in the environment for only a short period of time compared to organochlorine herbicides.

Annuals, biennials, and perennials are most easily controlled at the seedling stage. Summer annuals should be

treated in the spring, and winter annuals in the fall during germination. Biennials are best treated as rosettes in the fall. Woody perennials can be effectively treated at any time of the year. Herbicides can be applied to cuts or notches in the trunk or stumps after cutting. The vegetative stage of annuals and perennials is only moderately controlled with herbicides, and control during seed set is largely ineffective. Aquatic vegetation is best treated when the foliage is above water and likelihood of rain is low.

Several invasive weedy plant species are of particular concern in wetlands, including creeping buttercup, reed canary grass, purple loosestrife, Japanese knotweed, and blackberries. These species must be removed or controlled for successful wetland restoration. The following information can assist with the control or eradication of these species.

Creeping Buttercup. There are many species of buttercup native to the Pacific Northwest. However, one of the most troublesome, the creeping buttercup, is from Europe. This buttercup, which was probably originally introduced as an ornamental, is common in lowland pastures and wetlands. It can be recognized by its leaves, which are hairy blades divided into 3-toothed lobes attached to long stalks. Creeping buttercup is a perennial and reproduces by seeds and creeping stems that root at lower nodes. It is very invasive and capable of out-competing other plants. An additional problem is its toxicity to livestock and wildlife.

Creeping buttercup is easily killed by cultivation if the ground can be tilled several times during a fallow period. However, unless water control structures are available, many wetlands are either not dry enough to till, or not dry long enough to repeatedly till over a period of time. Herbicides such as MCPA and glyphosate are effective. Check the current *Pacific Northwest Weed Control Handbook*⁶² for application rates and other possible herbicides.

Reed Canarygrass.^{60, 61} Although now believed to be a native of the northern part of North America, reed canarygrass is not native to western Oregon. The strain found in the Willamette Valley is thought to have been introduced from Europe. It is very aggressive, frequently invading pastureland, stream bottoms, and wetlands, and is problematic for wetland restoration. It is a vigorous, tall-growing plant with aggressive underground stems or rhizomes. Mature plants are intolerant of deep shade but can tolerate extended periods of soil saturation and ponding as well as seasonal dry soil conditions.⁶¹

Reed canarygrass reproduces by both seeds and vegetatively. It produces copious amounts of seeds that have no dormancy period and can germinate as soon as ripe. Seeds have a high germination rate. Vegetative reproduction is by radial expansion of shallow rhizomes. Studies have shown

that up to 74% of new shoots originate from vegetative growth rather than seeds. In the Pacific Northwest growth may start as early as mid-December with foliage reaching two feet in height by late-March.

Control & Elimination. Reed canarygrass can be eliminated by tillage. Most rhizomes are in the upper 6-8 inches of soil. Tillage kills top growth and eventually exhausts below-ground energy reserves. To maximize removal of energy reserves, disking or plowing should occur as the plants are beginning to flower. In the Willamette Valley this is usually May-June. Several tillage operations at about two-week intervals are required.

Tillage is relatively inexpensive, the results are evident within a few days, and it creates a seedbed for reseeding. It does, however, require equipment access to the site, which may be limited by flooding or wet soils, and soil left unprotected is susceptible to erosion and weed invasion.

Chemical control is an effective means of removing reed canarygrass. Currently, only glyphosate (Rodeo®) is approved for application for emergent and marginal vegetation. Other chemicals may be appropriate, depending on the site, and are identified in the current *Pacific Northwest Weed Control Handbook*⁶² available from the Oregon State University Cooperative Extension Service. Application to foliage should be uniform. To facilitate even coverage by spray equipment, application around boot (leaves fully emerged) or late-boot stage is most practical, generally late April-May. Followup treatments in late summer (September) are usually necessary and effective.

Herbicide application is relatively inexpensive, revegetation is more successful because competition is reduced, and properly applied chemicals are very effective in eliminating reed canarygrass. The biggest disadvantages are that herbicides effective on canarygrass are nonselective and spring applications can aggravate other weed problems such as establishment of Canada thistle. In addition, many landowners prefer not to use chemicals.

Mowing depletes much of the carbohydrate root reserve. Grass should be mowed when large amounts of foliage are produced but before energy is transferred from the leaves to the rhizomes. This is usually at or near flowering. Plants will respond by producing more shoots which should be mowed again when they are approximately 4 inches tall. This forces the plants to again develop new shoots, depleting energy reserves. Several mowings will be necessary.

Advantages to mowing include ease at which defoliation can be gauged and ability to alter mowing frequency and severity as needed. Also, desirable plants may be released from the shade of the canarygrass. The primary disadvantage

is accessibility; many areas where canarygrass is a problem are not suitable for mowing.

Burning can remove vegetative growth before spraying but, by itself, will not eliminate reed canarygrass. Burning should be done in the early spring when fire danger is low. Costs are low and fire may open up the canopy and release suppressed native plants such as sedges and grasses. Disadvantages are the requirement for a permit, fire does not by itself eliminate canarygrass, and canarygrass in wet meadows may actually be stimulated by burning.

Flooding has limited application. Reed canarygrass can tolerate periodic flooding, especially flowing water. It does not tolerate continual deep ponding, especially during warm weather. However, there are cases where canarygrass has tolerated inundation by at least one foot of water for two years before succumbing. Advantages of flooding are its effectiveness in improving wetland habitats and the potential for remnant wetland plants to respond and colonize the site. The major disadvantage is the need for water control structures to hold water during dry seasons. Many small wetlands and wet prairies do not have such structures.

Competition and shading have been effective in controlling reed canarygrass. Canarygrass will not tolerate shading greater than 40%. Shade may be provided by natural or artificial means. Artificial methods include mulching with bark, weed barriers, and black plastic. Grass is typically cut to within a couple inches of the ground before mulching. Advantages of mulching include availability of materials, ease of installation, and suitability for small areas. Disadvantages include limited effectiveness of bark mulching to keep rhizomes from increasing and penetrating the surface, sensitivity of black plastic to UV breakdown, limitation to small areas, and the refugia barriers can provide for rodents.

Shading by trees, shrubs or rapidly growing grasses, possibly in conjunction with mulching, can control reed canarygrass. Species that develop foliage early in the spring or that will out-compete canarygrass work best. In areas where reed canarygrass has been removed by spraying or tilling, consider seeding species that will present a significant obstacle to canarygrass establishment. These include tufted hairgrass, slough grass, spike bentgrass, bluejoint or Canadian reed-grass, turf-forming varieties of red fescue, meadow barley, or sedges such as bigleaf sedge. Seedings should be heavy (25-50+lbs./acre).

A recent publication⁶¹ suggested a method of using pole plantings to out-compete and shade out canarygrass. Large poles (2-4 inches diameter at butt, 1-3 inches diameter at top, and 6-8 feet long) of black cottonwood and willow are collected during the dormant season (November-February). Lateral branches are removed and poles are planted with half

to two-thirds of the bottom end in the ground. Make sure that the bottom of the pole is planted and not the top. Holes for planting can be dug with a post hole digger or auger; do not drive posts into the ground. Protection from rodent and deer damage will likely be needed.

Purple Loosestrife.^{64, 65 112} Purple loosestrife, a herbaceous perennial, has spread into and degraded temperate North American wetlands since the early nineteenth century when it was introduced from Europe as a contaminant of ship ballast, medicinal herbs, and garden plants. It is an aggressive rhizomatous invasive that can reach heights of six feet with 30-50 stems forming wide-topped crowns that dominate the herbaceous canopy. One mature plant can produce more than two million seeds annually. Seeds are easily dispersed by water and in mud adhering to aquatic wildlife, livestock and people. High temperatures (> 70 F°) and open, moist soils are required for germination, and seedling densities can approach 2,000 plants/ft.² A woody rootstock serves as a storage organ, providing resources for growth in spring and regrowth if the above-ground shoots are cut or damaged.

Several control methods are currently used for purple loosestrife, including mechanical, chemical, and biological. Small infestations can be controlled by removing all roots and underground stems. Removal of all plant material is important. Small segments of stems can become rooted and reestablish the infestation. Areas where plants have been removed should be watched closely for several years to ensure that plants have not regrown from missed roots or seeds. Removed plants and roots should be dried and burned, being careful not to further spread seeds.

Herbicides can be used to treat loosestrife infestations in larger areas. Glyphosate (Rodeo®, RoundUp®) provides good control when applied from July to early September. Check the most recent edition of *Pacific Northwest Weed Control Handbook*⁶² for additional chemicals that may be effective against purple loosestrife. For Rodeo® and RoundUp®, a non-ionic surfactant approved for aquatic sites at 0.25% vol must be added to spray in or near water. Best results have been obtained when glyphosate is applied as a 1-1.5% concentration at bloom or shortly thereafter. Since glyphosate does not provide residual control, treated areas should be monitored for regrowth from roots or seeds and retreated if necessary.

A 2,4-D formulation labeled for use near water applied as a 2% solution will prevent seedling establishment when applied in early fall or spring. However, these herbicides are not selective and seedlings of preferable species will also be prevented. Garlon®, which is a selective broadleaf herbicide that will not harm cattails, sedges, or grasses, will provide good purple loosestrife control when applied in the pre- to early-flower or late growth stages. Garlon is not labeled for

use in water but can be used up to the water's edge. It should be applied as a 1-2% solution and will provide residual seedling control.

Three biocontrol insects have also been used on purple loosestrife. Two leaf-feeding beetles, *galerucella pusilla* and *galerucella californiensis*, have been most successful. These insects overwinter as adults and lay eggs in May. The adults and larva feed on the leaves and flowers. The biggest disadvantage to biological control is that target populations are not eradicated, only reduced. In addition, in the case of insect biological controls, the control is susceptible to pesticides. Mosquito control programs have hampered use of the effective leaf-feeding beetles in some areas.

Japanese Knotweed.^{5, 65, 66} Japanese knotweed is an upright shrublike herbaceous perennial that can grow to 10 feet in height. It is a native of eastern Asia and was introduced to North America as a garden ornamental in the late 1800s. It can be identified by its reddish, smooth bamboo-like canes, which are hollow, jointed and swollen at the nodes. A papery sheath is present above each node and at the base of the leaf stocks. Stems die back each year after the first frost, leaving tall, brown skeletons. Leaves are alternate and large, about 6 inches long and 4 inches wide.

Japanese knotweed can tolerate a variety of adverse conditions including both salty and acidic soils, full shade, high temperatures, and drought. It is found near water sources and, because of its extremely aggressive nature, is a threat to wetlands. Thick, stout rhizomes up to 30 feet long develop into dense mats. Once developed, these mats obstruct root removal. Shoots generate from the rhizome and form the roots when near the surface or buried up to 6 feet deep. Knotweed reproduces by both seeds and rhizomes, but most often spreads by rhizome fragmentation and scattering.

Small initial populations of Japanese knotweed can be removed by grubbing out entire plants including roots. Juvenile plants can be hand pulled when soil conditions are right. It is important to remove all of the plant and roots as any remaining parts will sprout. Digging is not recommended for larger stands because of the difficulty of removing all plant parts. All removed plant parts should be bagged and either burned or sealed and buried.

A cut-stem treatment can be used in areas where plants are established or vines have grown into the canopy. Cut stems about 2 inches above ground level and immediately apply a 25% solution of glyphosate (RoundUp® or Rodeo®) or triclopyr (Garlon®) and water to the cross-section of the stem. A subsequent foliar application of glyphosate may be needed to control new seedlings and resprouts.

Foliar spraying may help control large infestations, however the recommended herbicides are not selective and will kill all vegetation in the treated area. Thoroughly wet all foliage with a 2% solution of glyphosate or triclopyr and water. A 0.5% non-ionic surfactant is recommended to penetrate the leaf cuticle. Spraying should occur when temperatures are above 65°F.

Blackberries. Himalayan and cut-leaf or evergreen blackberries are not tolerant of wet conditions but can be major invaders of drier areas in wetlands such as islands and berms. See Control of Exotic Invasives section in the Oak Woodlands chapter.

Scotch Broom. Scotch broom is not tolerant of wet conditions but can be a major invader of drier areas in wetlands such as islands and berms. See Control of Exotic Invasives section in the Oak Woodlands chapter.

False-Brome. False-brome is a relatively new pest species that is rapidly spreading in the Willamette Valley. It has a wide ecological tolerance and can be a problem invader in restored wetlands. See Control of Exotic Invasives section in the Oak Woodlands chapter for more information.

OTHER RESTORATION CONSIDERATIONS

The value of restored wetlands to wildlife can be enhanced by integrating structures such as snags, nest boxes, logs and woody debris, and islands.

Snags should be retained at a restoration site if they exist. If absent, or if additional snags are needed, they can be created by killing live trees (see Tree Removal and Snag Creation in the Oak Woodlands chapter). Snags can also be created by installing logs or salvaged utility poles. The latter are less preferable because they are generally treated with a preservative that may be harmful to or repel wildlife.

Nest boxes are used as substitutes for natural cavities. They are generally sized and located for target species and range from bird nest boxes to bat roost boxes to squirrel boxes. Box dimensions, entry hole diameter and placement, and installation location vary according to species for bird nest boxes. Squirrel nest boxes are relatively large and have an entry hole placed on the side and near the back to allow easy access from the pole or tree on which they are mounted. Designs and location instructions for bird and squirrel boxes can be obtained from the ODFW web page at <http://www.dfw.state.or.us/ODFWhtml/springfield/springfield.html>, an ODFW publication entitled *Nature Scaping*;⁵⁶ or the University of Washington publication *Landscaping for Wildlife*.⁵⁷ Designs for bat roost boxes are continually being refined with the "rocket box" currently considered best. Bat box designs, including the "rocket box," can be obtained

from Bat Conservation International at <http://www.batcon.org>. Nest boxes have their limitations. They may not be readily accepted by some cavity-nesting bird such as woodpeckers, must be properly constructed and placed, and require maintenance.

Logs provide habitat for a variety of animals and plants. Logs anchored to the shore and floated out into emergent vegetation, aquatic beds or open water provide haulout sites and pathways for water birds, reptiles, and amphibians, as well as substrate for wetland plants. They also provide cover for fish. To maximize their value, a diversity of logs of various species, lengths, diameters, and degree of decomposition should be used. They can be anchored with cables attached to concrete blocks or partly buried.

Although they may appear unsightly, *debris jams* or piles comprised of limbs and logs also provide valuable habitat for animals and plants. They provide haulouts for animals and escape or hiding cover for animals and fish. They also provide decomposing wood, which is used by invertebrates that are important in the food chain. When placing these structures consider that submerged wood decomposes much slower than wood exposed to the air and that decomposition rates vary according to species of wood. Cedars are the slowest to decompose, followed by hardwoods such as ash and maple, followed by softwoods such as Douglas fir. Complete decay of coniferous softwood in western Oregon takes about 20 years for a 5-inch diameter log, 60 years for a 13-inch log, and 150 years for a 40-inch log. A multiplier of 1.5 can be used to estimate decay rates for submerged wood.

Islands provide structure diversity in open-water wetlands. They provide additional edge, which is valuable to wildlife, and shallows that support emergent vegetation. They can also provide shelter to animals and plants from the prevailing winds, and refuge from terrestrial predators and scavengers on the mainland. Islands can be created by placing fill in open water or, if ponds are being excavated, leaving islands of exposed ground. Shorelines should vary, with some portions sloping steeply into open water and others having a shallow gradient. The latter will allow variable zones of soil saturation, encouraging establishment of a variety of emergent plant species. The crest or top of islands may support a riparian or grass community.

REVEGETATION

If disturbance has not been excessively severe or long, the natural seed bank is often adequate for revegetating a site.^{37, 41} For small areas or areas that are likely to be overwhelmed by undesirable invasive plant species, propagation may be desirable. Revegetation by propagation is

recommended for areas where <15% of an existing wetland is vegetated with desirable perennial species.⁴¹

PLANT SPECIES SELECTION: STRUCTURE

Plant species selection will depend on the type of wetland (swamp, marsh, wet meadow or prairie, and shallow water), structure or physical and species complexity of the target plant community, and shape of the wetland being restored. To restore structural complexity, the desired horizontal and vertical structure must be defined. Horizontal structure includes plant spacing, patch shape and size, and frequency of patch occurrence. For example, a seasonal shallow-water wetland may have clumps of shrubs such as wild rose and spirea dispersed throughout on elevated areas. The horizontal structure in this case would include the density and spacing of plants in each clump (a few plants spaced widely apart versus many plants packed tightly together), the size and shape of these clumps (large versus small, and irregular versus geometric shape), and frequency of occurrence of these clumps throughout the wetland. An additional consideration would be the distribution of the clumps, i.e. random or clustered. Other important horizontal components are logs, stumps, and other structures that provide habitat for small mammals, amphibians, reptiles, and invertebrates.

Vertical structure refers to growth layers. For example the vertical structure of a marsh would be relatively simple, with sedges, rushes, or other herbs forming the ground layer. In contrast, the more complex vertical structure of a bottomland hardwood forest might include trees such as Oregon ash, cottonwood, and oak in the overstory canopy; smaller growth-form trees such as hawthorn and cascara in a midstory; shrubs such as wild rose, Indian plum and spirea in the understory; and sedges and herbs forming the ground layer.

Wetland shape influences structure, plant species composition, and wildlife value of a wetland. Simple, regular plant community structural patterns tend to be associated with regular shapes, such as circles or squares, and often present an orderly progression of plant communities in concentric rings or linear bands. For example a small round pond wetland is frequently comprised of open water in the center surrounded by concentric rings of emergent herbs such as cattails or rushes and low shrubs such as willows (Figure 9a. "target" pond, next page). More complex community structural patterns are associated with irregular shapes and are usually characteristic of a more mature system. An example is an irregularly shaped pond wetland with varying depths and topography. Such a wetland might support irregularly shaped stands of emergent vegetation in deeper areas; emergent sedges, rushes, and herbs in shallows; emergent shrubs in seasonally inundated areas; islands with shrubs or grasses; and banks lined with willows or grasses (Figure 9b. "diverse target" pond). Because it offers much

more structural and plant species diversity, the latter is more valuable to wildlife.

PLANT SPECIES SELECTION: SPECIES

Attention should be given to the growth form and origin of potential plant species. Obviously, tree species such as cottonwoods will not provide a low-shrub structure, and snowberry and spirea are not going to provide a forest canopy layer, although they will provide a shrub understory.

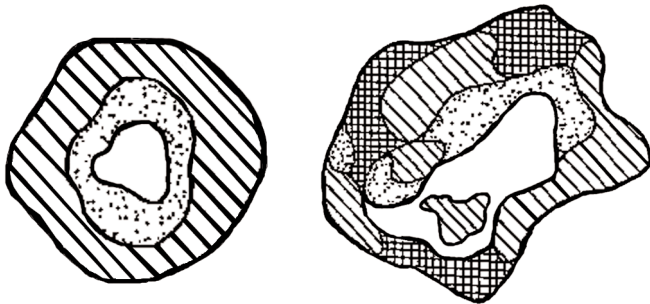

Figure 9a. “Target” pond. Figure 9b. “Diverse target” pond.
Images courtesy of the Washington State Department of Ecology.

Non-native species should be avoided. If non-native grasses or forbs, such as legumes, are used to stabilize newly exposed soils, non-aggressive annual species should be used. Annual cover crops of barley or annual ryegrass are acceptable for erosion control, as these species do not compete with native plants over time. The local NRCS office or Soil and Water Conservation District (Appendix D) can recommend appropriate non-native species for your area.

The following invasive plant species **should not be used for revegetation**, even though they are available from commercial nurseries and are sometimes recommended because they provide rapid cover, control erosion, and are considered aesthetically pleasant. These species include creeping buttercup, narrow-leafed cattail, soft rush, reed canary grass, Scot’s broom, yellow iris, and purple loosestrife. See Appendix A for appropriate plant species for wetland revegetation and sources.

It is important to determine what species will be planted early in the design process, particularly if large numbers of plants will be needed. Many native species are of limited supply or not always available from commercial suppliers. It may be necessary to order a year in advance so that nurseries can grow plants. Plants or seed can also be collected, but permits will be necessary if collection is from public lands (see Appendix G). To maximize plant survival and maintain the genetic integrity of restored wetlands, plants that are indigenous to the project area should be collected if possible.

TYPES OF PLANTING

The actual means of plant installation depends on habitat type, desired structure, hydrology, and substrate. There are four propagation methods typically used to establish plants in wetlands: seeding, cuttings, transplanting, and container grown/bare root planting.

Seeding.^{40, 41, 42, 58} Seeding is the least expensive method of establishing wetland plants, especially for larger areas. It also has the advantage of being able to store seed until needed. However, seed availability for some species is limited; some seeds have special germination requirements; and many are difficult to handle, being small, light weight, and having stiff hairs or barbs. Also if seeds must be collected from the wild, costs increase rapidly.

Most wetland plants need at least three things to germinate: light, heat, and water. The need for light means that seeds need to be seeded on or very near the surface and covered with little or no soil. Many seeds have very hard seed coats that take up to one year or longer to break down enough for germination. Some species require special stratification treatments to prepare for planting. These treatments vary from mechanical scarification or acid washes to pre-chilling or high temperatures. Heat is one of the essential requirements for germination and growth.

Water levels during seeding and germination can be problematic. Germination requires adequate water, but not so much that seeds float away. Without good water control, when water enters a system the newly planted seeds will float to the surface and move to the water’s edge, where wave action deposits them in a narrow band around the wetland. Typically the seed will germinate in these bands and establish plant cover, but the bottom of the wetland will go unvegetated.

Wetland species that can be planted by seed include tufted hairgrass, hardstem bulrush, ovid spikerush, sawbeak sedge, Baltic rush, slough sedge, mannagrasses, and tapered rush. These species grow quickly and produce seeds prolifically. Other plant species to consider for seeding wetlands include Oregon bentgrass, winter bentgrass, common spikerush, needle spikerush, and knotweed or smartweed. Contact the suppliers listed in Appendix A for their most recent list of available wetland plants. The market is advancing rapidly and seeds of additional plant species are becoming available all of the time. Appendix B lists seeding rates and depths for common native species including wetland plants.

Seed collection⁵⁹ should be from dense, reasonably pure, stands near the project area. This increases the likelihood that seeds are from plants that have adapted to local hydro-

logical and environmental conditions. Permits will be required if collecting is to occur from public property (see Appendix H.). Obtain permission from landowners to collect on private property.

Seeds should be harvested when the majority are ripe. This can be determined for most common species by referring to the publication *Propagation of Pacific Northwest Native Plants*.³⁴ The two most common methods of harvest are stripping the seed or seed heads off the stalk, or cutting the heads off the stalk with hand clippers below the seed heads. Seeds and seed heads should be placed into brown paper sacks. Paper sacks are used because the seeds are dried in the sacks. After collection, seeds and seed heads need to be cleaned in a seed cleaner like a Crippen Cleaner.

Collection techniques for some wetland plant species are:

- **Baltic rush.** A dense stand can be mowed to obtain enough seed, but the stems must be kept upright to keep from losing seed. A large grocery bag of bulk material (seed heads and stems) will yield about 1/16 cup of seed. Shattering dates (when disturbance to plants will cause seeds to drop) are generally mid-July in the Willamette Valley.
- **Hardstem bulrush.** Seed can be easily collected in good volume by collecting seed heads and stalks. One large grocery bag of materials often yields >1 cup of seed. Water depth can affect ease of collection. Shattering dates range from July to August.
- **Knotweed or smartweed.** Seeds from these species are considered some of the easiest to collect, although identification of individual species can be confusing. Seed heads can be picked by hand and 15-20 will often yield 1/2 cup of seeds.
- **American bulrush** (also known as three-square bulrush). Seeds are easy to collect from dense stands using hand clippers. One large grocery bag of bulk material can yield up to 2/3 cup of seed. Collect before September.
- **Common spikerush.** Dense stands can be mowed to get seed. Seeds are held tight. One large grocery bag of material may yield 1/2 - 2/3 cup of seed. This is a major wildlife food source which is often difficult to beat the animals to.

Seedbed preparation and seeding generally follows local agricultural practices. Extensive preparation such as disking, cross-disking, harrowing, and cultipacking may not

be applicable to all sites but will provide good germination at relatively low cost. Some species may be drilled into existing wetlands during low-water or dry periods with minimal disturbance using a no-till drill. Several contractors and the U.S. Fish and Wildlife Service (see Appendix D) have drills. Hydroseeding or hydromulching may be applicable where dense plantings or site conditions make tractor or hand seeding and seedbed preparation difficult. Hydroseeding is more costly and vehicle access is required.

Dormant seeding (seeding during late fall or winter after plants have gone dormant) is the preferred planting period. Usually, plantings early in the dormant season result in greater seed emergence than later plantings. Some species may be seeded mid-April to October if adequate moisture is present for germination and to support seedlings. Planting during this period may require irrigation. To ensure adequate moisture for germination and growth but not so much that seeds float away, seasonally flooded areas should be seeded after water levels have dropped but while the soil remains moist.

TRANSPLANTING SPRIGS, PLUGS, RHIZOMES, AND TUBERS^{40, 42, 58}

Sprigs are divisions of herbaceous plants, such as sedges and rushes, that include a single stem or cluster of leaves and associated soilless roots. Slough sedge and small-fruited bulrush are examples of species that are typically planted as sprigs. Planting sprigs during the spring and fall results in good survival rates. Summer plantings are okay in areas with adequate moisture.

Plugs are similar to sprigs except they include associated soil. They can be obtained by harvesting them or growing them. Harvesting wildplant plugs is more economical, does not require propagation facilities, and inoculates the restoration site with soil micro-flora and fauna imported with the plug. Also, use of plugs harvested from wetlands adjacent to a restoration site insures plant strains native to the area. However, nursery-grown plugs have shown higher establishment rates and spread faster and further. The decision on which type of plugs to use will depend upon availability of funding, availability of propagation facilities if plugs are to be grown locally, and desired establishment and spread rates.

Plugs can be cut and removed using a 4-6 inch diameter PVC pipe fitted with a handle. It is not necessary to dig deeper than about 5-6 inches. This will get enough root mass to ensure good establishment. To minimize the impacts of removing plugs, no more than 1 square-foot of material should be removed from a 4 square-foot area. Where impacts of removal are not a concern, larger plugs (16 x 16 inch, 10-12 inches deep) can be removed with backhoes or excavators. These can either be placed whole into the restoration site or divided into 6-8 smaller plugs. They can be chopped

into smaller plugs with a shovel or cut relatively accurately with a small saw so that they fit into predug or predrilled, set diameter holes. Make sure the plugs are long enough to be in contact with the saturation zone at the restoration site. An easy way to cut plugs to the proper length is lay the large plug on its side on a sheet of plywood and use a saw to cut the bottom off to the desired length. Plugs can be harvested at almost any time of year. During summer months, cut the tops of the plants down to about 4-5 inches above the potential standing water height at the project site, or 10 inches, whichever is taller. Plugs should be maintained at less than 75° F, kept moist, and protected from drying winds while being transported. This can be done by placing them in Styrofoam coolers with enough water to cover the root systems. Plugs should be planted as soon as possible after collection.

Plugs can also be grown in a greenhouse. Seeds of most wetland plants except rushes need to be stratified, or "fooled" into germination, by mimicking the environmental conditions that they would have been subjected to outside over a winter. This can be done by placing seeds in small plastic containers filled with distilled water. About a half-ounce of loose sphagnum moss is placed in the water in the bottom of the cup, and then a coffee filter with seeds inside is nestled down into the moss. Containers are then placed in a dark cooler for 30 days at 32-36 °F. These seeds are then planted in a 1:1:1 mixture of sand, vermiculite, and peat in Rootainers®. The large hole in the bottom of the Rootainers® needs to be plugged to keep the planting medium from washing out when water is added. This can be done by crumpling a paper towel and shoving it into the mouth of each cell. Five to 10 seeds are placed on the surface of the soil in each Rootainer® and the soil firmly packed. A 2 x 2 inch wooden tamp works well and can pack the soil to sufficient firmness that a finger will barely make an impression.

Rootainers® with stratified seeds are placed in propagation tanks and the tanks filled with water to within about one inch of the soil surface. Seeds are illuminated 24 hours a day with 400-watt metal halide lamps for the first month. After one month the lights can be turned off. Covering the tanks with clear plastic while the seeds are germinating will help keep the environment warm and humid. Plugs will grow to full size and be ready for planting in less than 100 days. If a damping off of seedlings (sudden death due to the attack of fungi) becomes a problem, raise the water level enough to completely submerge the soil by one-quarter to one-half inch of water. After two weeks, lower the water level. This should subdue fungus. Do not flood the soil before seeds germinate or they will float out of the containers.

Plugs can be planted any time of year if adequate water is present at the restoration site. They should be planted on

18-inch centers. If insufficient plugs or funding are available to allow complete planting, plant plugs on 18-inch centers in 10 foot square patches and space the patches about 10 feet apart. Plants will spread into the unplanted areas over time.

The underground stems and storage organs produced by some plants are called rhizomes or tubers and can be used to establish plant populations. Advantages of rhizomes and tubers include ease of handling and, with proper installation, increased success. Wapato, hardstem bulrush, and common cattail are examples of species producing tubers that can be used to establish populations. Digging and replanting of rhizomes and tubers is best done during the spring, fall, or winter when plants are dormant. When dug, each piece should contain two or three new buds or shoots at the base of the old stems (tuber) or at the tips of rhizomes. They should be replanted just below the soil surface and the soil firmed down over each piece. Planting in shallow water should be completed before the area is flooded, making planting easier and reducing the chances of rhizomes and tubers floating away.

Cuttings.^{40, 42} Rooted or unrooted cuttings of woody species have been successfully used to revegetate wetlands, and much information on their collection, preparation, installation and use is available from local NRCS offices and Soil and Water Conservation Districts (Appendix D). To insure the survival and growth of cuttings in the field, competition with other plants must be minimized, browsing or grazing controlled, and adequate soil moisture maintained until plants are established.

Sitka willow, Pacific willow, black cottonwood, red osier dogwood, and Douglas spirea are easily rooted from cuttings and are probably the most frequently used species for direct sticking in the field (see reference 34 for additional species). Cuttings of these species are obtained from one year-old wood at least 3/8-inch in diameter. They are best planted in areas with adequate soil moisture throughout the growing season and where competing vegetation will be controlled. The size of the cutting should be determined by the hydrology of the site. Cuttings should be 18 inches or longer where surface and groundwater levels fluctuate. Longer cuttings are used where groundwater fluctuation and competition may hamper growth. Willow and cottonwood whips 4-5 feet long and 2-6 inches in diameter survive better than shorter cuttings.

Cuttings can be taken in the fall after plants become dormant and stored indoors in moist sand or sawdust until spring. They can also be taken in the spring before growth begins and planted directly in the field. Cuttings should be kept out of direct sunlight and drying winds during planting. A hole should be dug for each cutting; avoid any damage caused by pushing it into the soil. Depending on the species

and desired horizontal structure for the wetland, cuttings such as willows should be planted about 3-4 feet apart.

Container-grown, Balled and Burlapped, and Bare-root Plants.^{40, 42} Many of the plant species commonly specified for restoration plantings can be grown in containers, enabling larger plants to be installed onsite. Using containerized plants during the growing season optimizes chances for survival because the plants can be transported and held at the project site and installed with well-developed and intact root systems. In addition, container-grown plants often include fertilizer reserves in their growing media that can help the plants become established. Not all plants are well suited for transplanting from containers. Exceptions include vigorous species that spread by rhizomes, such as small-fruited bulrush and common cattail. These species can thrive in containers but the rhizomes quickly grow through the container's drainage hole, making transplant without damaging the plant difficult. A disadvantage of container-grown plants is their costs. Nurseries have invested much time and labor in these plants and must charge accordingly.

Field-grown shrubs or trees are generally supplied balled and burlapped. The plants are dug and their root masses with attached soil are wrapped with burlap for ease in storage and transport. Balled and burlapped plants that will be stored at restoration sites should be placed in shady locations and their root balls covered with moist wood chips.

Many trees and shrubs are available as bare-root materials during the dormant season, generally October to March. Bare-root materials should be stored onsite in moist wood chips. An advantage of bare-root stock is lower cost relative to other nursery grown plants.

Container and balled-root plants should be planted in a hole twice as deep and wide as the root ball. A power auger is frequently used to dig hole of adequate size. The hole should be backfilled with good quality soil so that the root collar of the plant is level with the surrounding soil level. A slow release fertilizer may be added to each hole before planting (see Fertilizer and Other Soil Amendments, below). When filling the hole around the root ball, it should be covered by at least one inch of soil to prevent drying. A basin may be formed around the plant to help hold water. Additional protection from drying may be provided by placing shredded bark or other mulch in the basin, making sure not to cover the crown of the root ball.

Bare-root plants should be planted during dormant seasons, late fall through early spring. Special care should be taken that plants are placed in a hole deep enough and wide enough to prevent recurving or "J-rooting". Containerized materials can be planted year-round if adequate moisture is

present. Because plants installed during the growing season may require extra care until they become established, most restoration plantings are done in the early spring or late fall when plants are just starting or ending their yearly growth. See Figure 2 (page 9) for some common problems to avoid during planting.

ADDITIONAL PLANTING CONSIDERATIONS

Wetland areas can be planted whenever there is adequate moisture to ensure plant survival. Planting times will vary, depending on the requirements for successful establishment of each species (see *Propagation of Pacific Northwest Native Plants*³⁴ for planting times and methods). Wetlands in the Willamette Valley tend to be wettest during the winter, spring, and early summer, making these the optimum seasons for planting. However, access may be the most difficult during these seasons due to high water and soft ground. Planting methods, such as drilling, that require equipment in a wetland are limited to seasons when the ground is tillable, generally summer through fall. Adequate soil moisture to promote seed germination and support seedlings is also a factor.

The rooting zones of transplants and cuttings must remain in the permanent water table or be irrigated until plants are established, often several years. Native species adapted to local water tables should be used, minimizing maintenance costs and maximizing long-term establishment of vegetation.

Planting emergent or aquatic species may present special problems. Turbid water obscures vision, deep water limits access, and moving water can wash out plants or seed. Two methods of overcoming these problems are enclosing rhizomes or tubers in cotton mesh bags weighted with stones, or pushing nails or fence staples into tubers to sink them. To firmly install tubers, rhizomes, or roots of emergent species, they should be planted before the planting area is flooded. An alternative, if a water control structure is present, is to drain the project area prior to planting.

FERTILIZER AND OTHER SOIL AMENDMENTS.⁴²

Fertilizers are typically not used in wetland restoration. Native plants are generally adapted to low-nutrient conditions and fertilizers tend to promote weed establishment. The need for fertilizers can be determined by monitoring plant growth to watch for signs of nutrient or mineral deficiencies or conducting soil fertility tests. Typical symptoms of most common nutrient or mineral deficiencies in plants are: retarded growth and leaves with a pale green color (nitrogen); slight mottling and brownish-yellow spots on leaf tips (potassium); yellow leaves with green veins (iron). With proper planning, containerized plants can be

grown in a soil mix containing slow-release fertilizer that will provide nutrients throughout the establishment period. Incorporating fertilizer in the soil mix may also eliminate the need for surface applications and reduce algal blooms, water quality problems, and weeds. Fertilizers that have been used successfully in wetland plantings include Osmocote® controlled-release pellets and Agriform® controlled-release tablets. Both supply nutrients for several months to over a year, depending on the release times of the formulations. Agriform® tablets are easier to handle due to their larger size. Individual tablets can be pushed into the soil and buried. Osmocote® pellets can be enclosed in small burlap sacks and buried. Recommended application rates for emergent plantings are:

ADDITIONAL CONSIDERATIONS FOR ALL TYPES OF RESTORATION

Several long-term management issues accompany successful wetland restoration, including grazing and browsing control, pest control, and weed control.

BOX 6

FERTILIZER APPLICATION RATES FOR WETLAND EMERGENT

PLANTINGS⁴²

Product	Rate
Osmocote® 18-5-11 (12 - 14 month release)	1 fluid ounce per peat-pot, tuber, bulb or plug; ½ fluid ounce per sprig or rhizome
Osmocote® 18-6-12 (8 - 9 month release)	1 fluid ounce per peat-pot, tuber, bulb or plug; ½ fluid ounce per sprig or rhizome
Osmocote® 19-6-12 (3 - 4 month release)	1 fluid ounce per peat-pot, tuber, bulb or plug; ½ fluid ounce per sprig or rhizome
Agriform® (2-year release)	4 tablets per plant

GRAZING AND BROWSING CONTROL. Grazing or browsing by domestic and wild animals can prevent or severely limit establishment of wetland plant communities. Livestock, waterfowl, beaver, nutria, and deer can cause serious problems. How best to control problems will vary based on

site-specific conditions. If alternative feeding and denning sites are available nearby, grazing and browsing problems will be easier to address than if they are available only at the restoration site. If grazing or browsing becomes a problem, controls will be necessary until the wetland community is well enough established that it can withstand these impacts.

Fencing may restrict animal access to sites, plant communities, or individual plants. The type of fence and design will vary according to objectives. Livestock can often be excluded from an area by a simple single-wire electric fence. More sophisticated fences, such as poly-wire or "New Zealand" fence, can also be used. These will generally also exclude deer and elk. See the ODFW web page at <http://www.dfw.state.or.us/ODFWhtml/springfield/springfield.html> for designs and descriptions of these fences. Fencing constructed of chicken wire, or nylon or plastic mesh such as Geotex®, will deter nutria, beaver, and to some extent waterfowl. These fences need to be sturdy enough to prevent animals from pushing them over. They can also be defeated by both nutria and beavers, which have the ability to dig under them, and waterfowl, which can fly over them. Areas where exclusion of birds is necessary can be covered with the nylon netting available at most farm supply and builder supply stores. PVC pipe or electrical conduit can be used to support netting above the ground.

Fencing to prevent geese from swimming into smaller areas can be constructed by driving posts into the soil and connecting them with 1/8-inch nylon line rails spaced 6 inches apart. Rails should extend from 6 inches above the low water mark to 6 inches above the high water mark. Highly visible materials should be used.

Animals can be discouraged from digging up tubers and rhizomes by fastening chicken wire directly over them after planting. Wire should be removed after plants become established.

Individual plants can be protected by installing wire cylinders or tree shelters around them during planting. Designs for wire cylinders are available from ODFW at <http://www.dfw.state.or.us/ODFWhtml/springfield/springfield.html>. Be sure to use heavy enough material that animals up to 50-75 lbs. won't cave them in or crush them when leaning against them. Cylinders should be at least four feet tall and held in place by post. Tree shelters such as Tubex® or Treehouse®, which are made of plastic tubes ranging from 8 inches to 6 feet in length, may be used to protect seedlings from browsing. Tubes of ridged netting are also available in heights from 18-36 inches. Protective structures should be removed once plants become well established. If beaver damage is a potential problem, larger cylinders should be placed around plants as they grow.

Repellents and scare devices have limited effectiveness in keeping animals away. Repellents such as Big Game Repellent®, Deer Away®, and Ropel® can be applied to plants to deter deer. However, the wet climate of the Willamette Valley quickly washes these chemicals off, making them ineffective. Scarecrows often work for a short period of time but animals quickly become accustomed to them. Zon guns or propane cannons produce loud detonations that can be set to occur at regular or random time intervals. These may be effective in keeping animals away but animals can become accustomed to them. They should not be used close to human populations where they can be a disturbance.

A final reminder: Remember that working in wetlands in Oregon often requires a Removal-Fill permit from the Division of State Lands and a Section 404 permit from the U.S. Army Corps of Engineers. If species listed as threatened or endangered under the federal Endangered Species Act are present, additional permits may be necessary. For assistance in determining what permits are needed contact the Oregon Department of Fish and Wildlife, Lands Resources Division at 503-947-6301.

Bottomland Hardwood and Riparian Forests

The term "bottomland hardwood forest" is often used to describe forests, comprised of both hardwood and softwood tree species, that occur on floodplains.⁶⁹ These forests are frequently wetlands, typically occurring in the palustrine system, forested wetland class, and primarily in the broad-leaved deciduous subclasses of the U.S. Fish and Wildlife Service's wetland classification system.³⁵ Bottomland forests are, or may include, riparian areas. Riparian areas are defined by the U.S. Fish and Wildlife Service as "plant communities contiguous to and affected by surface and subsurface hydrological features of perennial or intermittent lotic and lentic water bodies (rivers, streams, lakes, or drainage ways). Riparian areas have distinctively different vegetative species than adjacent areas and, or species similar to adjacent areas but more vigorous or robust. Riparian areas are usually transitional between wetlands and upland."⁷⁰ Riparian vegetation can also be found around upland water bodies such as ponds and streams.

Historically, bottomland hardwood and riparian forests dominated the floodplains of the Willamette River and lower reaches of its tributaries.^{2,4} At the arrival of European settlers, these forests were estimated to have made up about 10% of the vegetative cover of the Willamette Valley.² Dominant tree species in wet sites included black



Bottomland hardwood forest in Buford Regional Park.

Photo by Bruce Campbell

cottonwood, Oregon ash, red and white alder, and willow. Dominant tree species on better-drained sites, on natural levees or high terraces included Oregon ash, Oregon white oak, bigleaf maple.^{4, 20, 96} Black cottonwood was often dominant along stream and river banks while ash trees were common on seasonally flooded and swampy areas. Characteristic shrubs

were serviceberry, Oregon grape, Indian plum, hazelnut, wild rose, elderberry, hardback, ninebark, cascara, and several species of willow.^{4, 20}

Since the 1850s, bottomland forests and riparian areas have declined by over 70% in the Willamette Valley.² Bottomland forests that historically formed up to a seven-mile wide corridor along the Willamette River have shrunk to an average of only a few hundred feet in width. Many streams have only thin strips or no riparian vegetation along them today. Most of these forests have been drained and cleared for agriculture or lost to flood control and channelization.^{2, 4} In addition, because these areas often provide the most favorable transportation routes, hundreds of miles of riparian vegetation have been removed for construction of roads, railroads, and associated realignment of channels and hardening of banks with concrete and rip-rap.

BOTTOMLAND HARDWOOD AND RIPARIAN FOREST RESTORATION

Complete ecological restoration of bottomland hardwood and riparian forests is generally not possible in most of the Willamette Valley. With the exception of some of the smaller tributaries, virtually the entire Willamette watershed has been modified by flood control and reclamation projects. Reservoirs for flood control and hydropower generation, channelization and hardening of banks, and realignment of channels have greatly changed the hydrologic regime of the system. The timing, magnitude, and duration of flooding and groundwater dynamics no longer resemble those that supported historic bottomland hardwood and riparian forestst.⁷¹ Consequently, restoration today means trying to restore the hydrology of an area as much as is possible, then matching the plant species to be established with the existing topography, soil, and hydrological conditions.

The following recommendations for restoring bottomland hardwood and riparian forests have been taken from a number of sources and modified to fit the Willamette Valley. Sources include *A Guide to Bottomland Hardwood Restoration*,⁶⁹ *A Guide to Regeneration of Bottomland Hardwoods*,⁷⁷ and *Riparian Reforestation and Revegetation for the Conservation of Land Birds in Utah*.⁷⁸ Before starting a restoration project, the preceding chapter on wetland restoration should be reviewed. Rather than repeat the recommendations in that chapter, the restorationist will be referred to them when necessary.

PROJECT PLANNING

A successful restoration project starts with good planning. The major steps in the planning process are:

1. Set goals;
2. Characterize the project site;
3. Select plant species to be restored;
4. Develop a design for the site;
5. Determine site preparation needs;
6. Determine best regeneration methods;
7. Develop a timetable for obtaining stock;
8. Develop a budget and sources of funds;
9. Obtain necessary permits.

PROJECT GOALS. For properties enrolled in the Wildlife Habitat Conservation and Management Program, goals are established in the required plan. Common goals include maintaining or enhancing existing bottomland or riparian forests, reestablishing a bottomland or riparian forest, or establishing a forested wetland. The landowner or cooperating agencies may also wish to establish more specific goals, such as a list of plant species to be maintained or established,

number of specific species occurring per given area, or insuring seasonal flooding to benefit wildlife species.

SITE CHARACTERIZATION AND EVALUATION. Much time and money can be wasted on a project if the objectives are not appropriate for the site. The evaluation may be informal, involving nothing more than a windshield survey, or it can be much more elaborate and expensive, involving the development of baseline information from hydrological, soil, and topographical analyses. The intensity of the evaluation will depend upon the restorationist's prior experience, degree to which the site has been altered, available funds, and requirements of cooperators. A detailed discussion of site analysis is presented in Site Assessment, p.17.

Briefly, the most important factors to consider in a site evaluation for bottomland hardwood and riparian forest restoration are climate, local hydrology, soils, possible plant competition and exotic invasive species, animals, disease, and human influence. Climate is one of the major factors affecting plant species distribution and growth. For example, a number of the riparian plant species found east of the Cascades in a desert environment with seasonally extreme high and low temperatures will not do well in the wetter, mild Willamette Valley. The best "rule of thumb" regarding climate is to use plant species that are native and well adapted to the area.

Site hydrology — the frequency, duration, depth, seasonality, and source of flooding or soil saturation — is the most important factor affecting the local distribution of bottomland and riparian forest plant species within their natural range. Consequently, considerable attention should be given to these factors in the project site assessment. Refer to Hydrology and Water Quality, p.18 for further assistance.

The main hydrologic systems in the valley are the larger alluvial rivers, minor tributary streams, sloughs, spring-fed creeks, seasonal backwater swamps, isolated depressions, and seep areas. These can have very different flooding patterns. High water and local flooding on the larger rivers that are regulated for flood control typically occurs during the heavy winter rains between late October and April, and snow melt in the Coast and Cascade Ranges between May and June. Minor tributary streams flood during heavy winter rains, and the duration of this flooding is usually short. For example, rivers such as the Luckiamute and Calapooia may flood adjacent lowlands extensively during heavy rains but be back within their banks within a few days. This cycle can be repeated numerous times during a winter.

Sloughs are usually old river or stream channels that have been abandoned naturally or cut off by channelization of the active channel. While some may dry up during the

driest summer months, many hold water year around. They obtain water from heavy rains, flooding, and percolation through the soil. Seasonal backwater swamps can develop in seasonal sloughs as well as low areas adjacent to rivers, streams, and drainage systems. They begin filling during the winter with the first heavy rains and receive additional water during flood events. Saturated soils are typical between November and June or July but they can become quite dry during the late summer.

The hydrology of isolated wet depressions can be similar to backwater swamps and sloughs in that they may start collecting surface water during the wet season, but they may also receive water from springs and seeps and remain wet throughout most of the year. Seeps are more dependant upon subsurface hydrology, which is usually specific to the underlying soils and bedrock. They may be seasonal or perennial.

Bottomland soils generally have more clay and organic material than upland soils, and therefore tend to have higher moisture-holding capacity, fertility, and productivity. Riparian woodlands and bottomland hardwood forests have a wide tolerance for soil types, but wetter vegetation associations are less dependant upon the soil type than are drier vegetation associations. Species growing on low terraces where water levels are shallow may grow on thin cobble. However, woodland species growing on mid- and higher-level terraces, where water levels may be much lower, require a greater depth of permeable soil. For a discussion of soil analysis for wetlands, see the Soils section in the Wetlands chapter, page 21.

It is important to evaluate current plant cover on the restoration site and also attempt to determine what type of plant competition may occur after restoration. Competition from invasive plants can reduce the survival and growth of desired bottomland hardwood and riparian forest species. In addition, heavy vegetation cover can also interfere with maintenance; harbor rodents that can consume plants, seedlings, and seeds; and cause a fire hazard.

Invasive plant species such as non-native grasses and shrubs — including Johnsongrass, creeping bentgrass, reed canarygrass, butterfly bush, and English hawthorn — can out-compete desirable plants for sunlight and nutrients and displace them. To successfully restore bottomland and riparian forest, these species must be controlled or eliminated. Under favorable conditions, native plants can also become invasive and establish monocultures (dense stands of a single species). Although species such as Oregon ash, Oregon white oak, and cedar are desirable components of bottomland and riparian forests, they can develop dense thickets and overwhelm an area if not managed properly. The potential for these problems should be assessed and plans made to

correct them, should they occur, before initiating a project. A windshield survey of nearby bottomland and riparian forests or advice from Oregon State University Extension Service, representative of the local soil and water conservation service or NRCS (Appendix D) will help the restorationist identify potential problems.

Both domestic and wildlife species can damage or destroy plants in a restoration project. Animals most likely to cause damage are cattle, deer, raccoons, beaver, nutria, and small rodents. See Seedling Protection and Grazing in the Oak Woodlands chapter, page 11, and Grazing and Browsing Control in the Wetland chapter, page 37, for ways to prevent animal damage.

Humans can also impact a restoration project. People may use the site as a play area, drive over it with ORVs, vandalize it, or accidentally douse it with herbicides from nearby farm or forestry operations. Fencing, signs, and good neighbor relations are about the only feasible ways to mitigate these impacts.

PLANT SPECIES SELECTION. Historic bottomland forests along the Willamette River, based on land survey records from the 1850s,⁴ were dominated by Oregon white ash, black cottonwood, big-leaf maple, and Douglas fir. Other tree species frequently mentioned were Oregon white oak, alder, cherry, and willow. The last three were probably associated with riparian areas. Understory vegetation included shrubs such as Oregon grape, salmonberry, elderberry, rose, spirea or hardhack, ninebark, and cascara. No mention of herbaceous plants by name was made in these surveys.

More recent studies of remnant bottomland and riparian forest^{8, 79} indicate that the dominant trees species are similar to those of the 1850s. Herbaceous understory species composition varied greatly between sites, with some being dominated by exotic grasses such as tall meadow fescue, common velvetgrass, colonial bentgrass, and perennial ryegrass, while others were comprised of primarily native forb and grass species. Many streamside zones were dominated by continuous stands of willow.

Plant species selection should be based on historic conditions as well as current conditions. If the habitat project involves maintaining a bottomland or riparian forest, plant species selection has already been made. If the project involves enhancement of existing forests or reestablishment of former forests, plant species selection is one of the more critical phases of the project. While complete ecological restoration is desirable, the goal of plant selection should be to match the plant species with the site topography, soil, and hydrologic conditions. Inappropriate choices can result in poor plant performance or a total planting failure.

There is no standard or recommended procedure for selecting species to be planted. A good starting point is obtaining information about what the pre-development forest composition on or near the site might have been. Sources for this information include a windshield survey of neighboring bottomland and riparian forests, or the Willamette Valley Land Use/Land Cover map and GIS data base available from the Northwest Habitat Institute at <http://www.nwhi.org/nhi/gisdata/willamette.asp> Information is also available from the Oregon State University Extension Service, local soil and water conservation district or NRCS (Appendix D).

Plants that are common in bottomland hardwood and riparian forest are listed in Appendix A. Once a tentative list of species has been developed, required growing conditions can be used to narrow the list to the appropriate species. Good sources of information on required growing conditions include *Guide for Using Willamette Valley Native Plants Along Your Stream*,⁷² *A Field Guide to the Common Wetland Plants of Western Washington & Northwestern Oregon*,⁷³ *Propagation of Pacific Northwest Native Plants*,³⁴ *Wetland Plants of Oregon and Washington*,⁷⁴ *Manual of Oregon Trees and Shrubs*,⁷⁵ and *Silvics of North America Vol. 1. Conifers and Vol. 2. Hardwoods*.⁷⁶

SITE PREPARATION. The purpose of site preparation is to create suitable growing conditions for bottomland and riparian forests. This may be nothing more than managing existing plant cover, or it may be more complex, such as reestablishing a water supply, eliminating or reducing existing plant cover, and soil improvements such as tilling and fertilizing. Sometimes no site preparation is necessary at all. If adequate water and seed sources are available, woody plant species may invade an area on their own. Studies have shown that in these cases site preparation by such things as disking may actually reduce the reestablishment of native woody species.

The landowner's goals and project design will determine what site preparation is needed. For example, a goal of restoring a seasonally wet abandoned field with a drainage ditch through it to bottomland forest with a riparian zone might include slowing the runoff (drainage) in the ditch; raising the water table along the ditch (and possibly the adjoining field if flat); planting willow cuttings along the ditch and cottonwood cuttings in the field; and appropriate shrubs, forbs, and grasses along the ditch and in the field. Preparation is site-specific, and assistance in determining what is needed can be obtained from the local soil and water conservation district, NRCS, or extension service (Appendix D).

REGENERATION METHODS. The appropriate regeneration methods for a site depend on several things. The first consideration is whether the goal of the project is to maintain existing

vegetation, enhance existing vegetation, or reestablish bottomland or riparian forest. Maintenance of existing forests usually requires no regeneration. Enhancement of existing forests may involve manipulating species composition and densities. If adequate seed sources are available or the forest is still productive, nothing more than control of invasive exotics is necessary; native forest and riparian plants will reestablish themselves. Reestablishment of a forest where one does not currently exist will likely require seeding and planting of propagules or cuttings.

The second consideration is what is being enhanced or restored: forest canopy, shrub layer, or ground layer. Propagules — such as seed, bare-root or container-grown starts — or transplants may be used to accomplish this. Where the water table is perennially high, such as riparian zones and low areas, cuttings may work.

The final factor is availability of time, funding, and propagules. Reestablishing vegetation with nursery stock can be expensive, time consuming, and dependent upon availability of stock. Seeding can often be done more quickly if seed is available. However, native seed can be quite expensive and may require special site preparation and drilling equipment.

Like site preparation, the appropriate restoration methods are site- and project-specific. Assistance in determining the appropriate methods can be obtained from the local soil and water conservation district, NRCS, or extension service (Appendix D).

TIMETABLE FOR OBTAINING STOCK. Demands for native plants and seed often exceed supply. Lack of planning for revegetation needs can set a project back by a year or more and require site preparation to be repeated. It can also lead to severe infestations of weeds and undesirable plant species while the site sits fallow. If seed or more than a few plants are needed for a project, it is a good idea to contact a grower well in advance to reserve stock. A partial list of providers is given in Appendix A. If plants are to be transplanted from areas where permits are required (public lands), these should be obtained well in advance. Appendix G provides information for obtaining permits.

FUNDING. A number of state and federal funding sources are available to assist landowners with habitat management restoration projects. Some of these have very limited funding, while others are typically under-subscribed. Some are competitive and some are not. See Appendix C for a listing of funding sources.

PERMITS. A fill and removal permit from the U.S. Army Corps of Engineers and/or the Oregon Division of State

Lands is required to place more than 50 cubic yards of material in, or remove 50 cubic yards of material from, a wetland (remember, most riparian and bottomland forests are seasonal wetlands). Projects that may not exceed the 50-cubic-yard limit in any one year but that cumulatively exceed 50 cubic yards of material over multiple years do require a permit. Many small restoration projects do not exceed the 50-cubic-yard limit, however, damming of larger channels or construction of ponds often does. If in doubt, contact either the Oregon Division of State Lands (DSL) or your local Soil and Water Conservation District (Appendix D).

The removal or fill of any material, regardless of the number of cubic yards affected, in a stream designated as essential salmon habitat, requires a permit from the Oregon Division of State Lands. The removal or fill of any material from the bed and banks of scenic waterways, regardless of the number of cubic yards affected, also requires a permit from DSL. To determine if your project site includes essential salmon habitat or is part of a scenic waterway, contact DSL (Appendix D) or go to their on-line assistance page at: <http://statelands.dsl.state.or.us/r-fintro.html> and click on "Essential salmonid habitat areas" for salmon habitat maps, or "State Scenic Waterways" for a list of scenic waterways.

Construction of ponds and water impoundments associated with wetland restoration may require a permit from the Oregon Water Resources Department (OWRD). Contact the OWRD (Appendix D) before starting a wetland restoration projects to determine permit requirements.

Remember, all permits are required before work begins.

RESTORATION DESIGN AND IMPLEMENTATION

WATER SUPPLY. Before any restoration can occur, the hydrology of the site must be restored or ensured. When localized drainage is the primary factor, it may be possible to restore the water supply by plugging ditches, removing or destroying drainage tile, or building or removing dikes or levees. In areas where land-leveling has flattened the topography, complete restoration may require use of earth-moving equipment to restore surface microtopography and hydrology. This generally requires some design and engineering that is beyond the interest or financial resources of many landowners. If this type of restoration is required, assistance should be obtained from either the local soil and water conservation district or NRCS. The Water Supply section in the Wetland chapter, page 21, provides recommendations on maintaining or restoring water to a project area.

Where hydrology modifications are the result of large-scale drainage or channel hardening, it may not be feasible to

restore the natural hydrology. Flood control projects and channel straightening have resulted in lowering of the water table in many areas of the valley beyond what can be restored by a typical project. It may, however, still be possible to partially restore an area under some conditions, such as flooding by winter high water, by planting bottomland forest and riparian species that match the hydrology.

SITE PREPARATION. The most common restoration sites in the Willamette Valley are abandoned agricultural lands, both tilled and untilled. Since old field sites are generally well suited for growing agricultural plants, they often require only minimal preparation to grow trees and other forest vegetation. Trees have often been planted successfully in these areas with virtually no site preparation. The method of regeneration is the primary factor in determining the type and level of site preparation. For example, if seedlings are to be mechanically planted, the site shouldn't be disturbed unless there is substantial soil compaction. Crop stubble and standing weeds should be left alone because they tend to provide better support for planting equipment. If seedlings are to be planted by hand, crop stubble should be left but standing weeds should be mowed. For machine planting in heavy clay soils, common in much of the valley, the site should be double-disked the fall prior to planting to prevent cracking of the soil along the furrow lines during dry weather. Silty or lighter soils not prone to cracking can be planted without tilling.

Many formerly tilled fields have soil compaction from repeated use of farm machinery. This can easily be overcome by disking. Ideally, disking should occur no more than two months prior to planting. However, disking may need to occur earlier if mid- to late-winter planting is planned, or if flooding is possible. Two passes with a disk plow or harrow should be made to a depth of at least 6 inches but preferably 8-14 inches. Final preparation immediately prior to planting can be done with a cultipacker, a disc-like farm implement that cultivates only the upper few inches of soil.

If compaction is especially severe, subsoiling with a chisel plow or ripper is a good idea. Subsoiling is most effective when the soil is dry, and should be done far enough in advance of planting to allow rainfall to close up and firm the soil. Normally, the soil should be ripped to a depth of 18-24 inches. In areas where erosion may be a problem, ripped furrows should be oriented with the landform contour. If trees are to be planted in rows, spacing of the furrows should correspond to the desired spacing.

Small areas can be prepared for seeding using a small tractor and implements, or a garden tiller. Be sure to cultivate only the upper few inches of soil. Deep cultivation can expose unwanted weed seed. If weed infestation is

anticipated, allow weed seedlings to become established (approximately 6 inches tall) and then spray with a non-selective herbicide such as Roundup.® See Control of Exotic Invasives in the Oak Woodlands chapter, page 11, or Control of Unwanted Vegetation in the Wetlands chapter, page 28, for more information about the use of herbicides. If soils have become crusted or compacted during this process, they will need to be loosened again. Severe weed infestations may require several till-spray cycles before they are controlled.

Remnant bottomland and riparian forests, fallow tilled fields, hay fields, and pastures may have weed cover that needs to be reduced or eliminated as the first step in restoration. This will reduce plant competition and temporarily reduce the number of small mammals that could be a pest during restoration. An effective way of doing this in open fields is disking, because it reduces soil compaction and increases organic matter by turning the weeds into the soil. Other mechanical methods of weed control include brush hogs, mowers, scrapers, and bulldozers. In remnant forest, where some desirable vegetation and structural diversity exists, the aforementioned mechanical methods of weed control may have limited application. In these cases mechanical control may be limited to more labor-intensive methods such as hand removal or weed whackers.

Herbicides are a useful tool in controlling weeds where mechanical control is not practical or in areas with very heavy weed cover or noxious weeds. See Control of Exotic Invasives in the Oak Woodlands chapter, page 11, or Control of Unwanted Vegetation in the Wetlands chapter, page 28, for additional information on controlling unwanted vegetation and herbicides.

Prescribed fire is another tool that can reduce weed cover. Summer burns are relatively effective in reducing the cover of highly competitive pasture grasses. This method does have a number of limitations including safety, liability, and need for permits. See Prescribed Burning in the Oak Woodlands chapter, page 6, for additional information.

Willamette Valley soils are typically fertile, however, repeated cropping over time, or poor management, may have reduced their fertility. In general, nitrogen is the limiting nutrient, followed by phosphorus and potassium. If fertility is suspected to be low, soils should be tested and fertilizers can be added. The fertilizer and other soil amendments section in the Wetland chapter, page 36, provides recommendations for fertilizing wetland restoration sites.

SEEDING OR PLANTING? Direct seeding is very appealing because it is relatively inexpensive, often costing as little as half to one-third of what planting seedlings costs per unit area. However, cost can vary greatly depending upon price

of seed and labor, availability of suitable equipment, and success of seeding. Additional advantages include natural development of root systems compared to nursery stock that generally has pruned, balled up, or twisted roots. Seeds can also remain dormant for a period of time if adverse site conditions exist, and the planting window is much wider than for planting seedlings.

Disadvantages to direct seeding include the poor ability of newly germinated seedlings to survive stress, such as extended dry periods, because of their lack of energy reserves, and difficulty in handling some species of seed because of seed size, shape, and external structures, such as barbs or stiff hairs. Many species require special drilling equipment and medium, such as saw dust or vermiculite, to help pass the seed through the drill and control planting rates. In addition, the seeds of some species require scarification before planting. Seed availability can also be a problem, with the demand for seed for many native species exceeding supplies. The last disadvantage, and probably one of the greatest for many woody species, is slower establishment and development. Several years' head-start can often be gained by planting seedlings rather than seeds.

Advantages to planting seedlings include the knowledge of successful methods and techniques resulting from many years of use in reforestation; increased likelihood of success as compared to seeding; and faster initial plant development, although in the case of some trees there is little difference in the long-term.¹¹ There are also more commercial suppliers of seedlings than seeds. The major disadvantage is cost, which can be considerably greater than seeding. Seedlings also require more careful handling and care than seed, and seedlings can be preferred food for rodents and deer.

If restoration or enhancement of bottomland hardwood or riparian forests include seeding, *Propagation of Pacific Northwest Native Plants*³⁴ and *Willamette Valley Native Plants Along Your Stream*⁷² should be reviewed prior to selecting plant species to insure that the required germination and growing conditions exist at the project site. Appendix B provides approximate seeding rates and planting depths for the more common native plants in the Willamette Valley. Additional sources of information on propagating and establishing native trees and shrubs can be found in the *USDA-NRCS Technical Note Users Guide to Description, Propagation and Establishment of Native Shrubs and Trees for Riparian Areas in the Intermountain West* (<http://Plant-Materials.nrcs.usda.gov>), or an on-line guide from Canada at <http://www.volws.bc.ca/resources/resourcesframeset.html>. These sites also provide approximate planting dates.

Seeding Trees and Shrubs. There are several published guidelines for modifying and using agricultural planters to

plant tree seed, and the U.S. Forest Service has developed a machine for sowing acorns, however, this guide will only consider hand sowing. The modified or specially designed planters are intended for large reforestation projects in the southeastern United States and are not practical for small-scale Willamette Valley projects.

Direct seeding by hand can be accomplished using simple and inexpensive equipment. A metal bar, broomstick, or even a stick found in the woods can be used to make planting holes. The seed is then dropped into the hole and the hole closed with the planter's foot. The U.S. Forest Service has developed a hand tool that can make the job easier. The seed is dropped down the tube to a preset depth and the hole is closed by the planter's foot. Under favorable conditions, a planter using the Forest Service tool can sow oak acorns on 7-8 acres per day at a rate of 3,000-3,700 acorns per acre. A planter using a bar or broom stick can probably plant 5-6 acres per day.

Acorns and other large seeds can be sown successfully at depths of 2-6 inches with 3-4 inches being best. Sowing deeper may be preferable where there are lots of rodents or the soil surface is subject to freezing or drying out. Experience in the southeastern United States has shown that as many as 25% of the acorns sown in relatively weed-free old fields, and about 10% in sown in cleared bottomland forests, will produce trees that are still healthy 10 years later. Initial germination and establishment was as high as 80% but usually closer to 35 - 40%. Germination and survival rates for seeds of woody species found in Pacific Northwest bottomland forests have not been well documented but are likely comparable. Restoration of native oak stands in northern California documented from nearly 40% to over 60% emergence of valley oak seedlings in weedy and weed-free environments, respectively.³⁰ Plains cottonwood may have up to nearly 100% germination,⁸¹ and germination of bigleaf maple on the Oregon coast averaged 30-40% of the viable seed.⁸²

Based on the germination and survival rates from the southeastern United States, hardwood tree seed should be sown at the approximate rate of 700-1,500 seeds per acre. If a very large area is to be seeded, direct seeding may be done in rows to speed the process. However, this will result in the stand looking like a "plantation" until it is thinned. Random plantings present a more natural appearing stand. Spacing of seeds should be about 8-15 feet apart. Appendix B provides seeding rates and depths for some common native plants.

Seeding Forbs and Grasses. With the exception of a few tuberous species or species that are generally established by planting plugs, direct seeding is probably the easiest way to establish most native forbs and grasses. There are a number of different ways to direct seed, from hand sowing to

aerial seeding. However, since most bottomland and riparian forest management and restoration projects on private property in the Willamette Valley are small and undertaken by the landowner and/or cooperator, direct seeding techniques discussed in this guide are limited to those most likely to be useful. Those wishing to undertake larger projects will likely be working with cooperators such as the U.S. Fish and Wildlife Service, NRCS, or watershed council, who either have their own equipment or funds to contract equipment.

Areas that total less than an acre or are dispersed throughout existing forests can be seeded by hand broadcasting or a rotary spreader. The important element is relatively even dispersal of seed. Make sure that the seed is dry and relatively free of large pieces of leaves or stems. If the seed is wet or full of debris, the spreader will not operate properly, and even dispersal of seed by hand broadcasting is difficult. Seed should be set or covered by raking, either by hand or by attachment to the garden tiller.

Larger areas can be planted using a no-till drill or standard agricultural drill. See the no-till drill and no-till seedbed preparation sections in the Grasslands chapter, page 61, for more information. Follow the instructions with the seed or seed mixes for planting dates or ask the supplier.

Planting Seedling Trees and Shrubs is an old, well established method of reforestation. There are three types of plantings: bare-root, containerized, and transplants. Bare-root seedlings can be expected to survive and grow well as long as the site is not too drought-prone and soil conditions are favorable. They are less expensive, lighter, easier to transport, and generally easier to plant than containerized stock. Bare-root seedlings must be planted during the dormant season, usually December to mid-March on the valley floor and lower foothills.

Bare-root hardwood seedlings should have a top height of at least 18 inches. The root collar, that part of the root just below the ground surface, should be at least 1/4 inch thick. Larger seedlings with a top height of 24 inches and minimum root collar diameter of 3/8 to 1/2 inch are preferred where no site preparation or weed control will occur. The cost of larger seedlings may be greater, but their use will reduce mortality and ultimately be more cost effective. In larger restoration projects, planting costs can be considerably more than that of the seedlings, so the higher costs of larger, good quality seedlings may be offset by the reduced expense of planting a large number of seedlings. Seedlings larger than about 36 inches in top height are difficult to handle and really not practical for large-scale restoration projects.

Bare-root seedlings should have a good balance between shoot size and root volume. Roots should be healthy looking,

well developed with several lateral roots greater than 1/25 inch in diameter, and pruned to a length of about 8 inches. Seedlings with too much top growth will often die back and resprout from the root collar. If seedlings have too much top growth, top-prune them back to a favorable size. If "favorable size" is unknown, ask the local County Extension Service or OSU Extension Service horticulturist (see Appendix D).

In some cases it might be desirable to purchase top-pruned bare-root seedlings. Top-pruned seedlings are cheaper to ship, easier to plant, and may have better survival or less die-back on dry sites. Seedlings can be top-pruned after purchase using simple equipment such as a machete or pruning shears. Generally, few differences in long-term survival and growth have been found between top-pruned and unpruned stock.

Containerized seedlings may be appropriate when planting on harsher sites or outside of the dormant season because their roots are protected by the same soil they were grown in at the nursery. This can reduce transplant shock and ensures that the roots of the seedlings remain moist for longer periods of time.

Tubed or plug seedlings have features of both bare-root and containerized stock. Their densely compacted roots are enclosed only in a very small amount of soil. Tubed or plug seedlings are grown in specially designed flats, called liners, from which they are removed before delivery at the project site. Plugs can be planted using a bulb planter that extracts a plug of soil, leaving a cylindrical hole. They combine the convenience and low cost of bare-root seedlings with the higher probability of survival on harsh sites. However, they are less likely to survive during prolonged dry seasons than container seedlings.

There are some additional considerations for handling of seedlings. Because their roots are exposed, care must be taken to keep bare-root seedlings from drying out. They generally come from the nursery in bundles of 50-200 with their roots packed together and wrapped in sphagnum moss or some type of moisture-retaining material. If bare-root seedlings are not planted immediately, they should be stored in cold storage at slightly above freezing. They can be stored in a barn, shed, or shade for a few days as long as they stay cool and the roots don't dry out or freeze. They can also be "heeled-in" by breaking open the bundles and spreading them out in a V-shaped trench and their roots covered with loose soil. This should be done in a shaded area and the soil should be watered and gently packed to remove any air pockets. Heeled-in seedlings should be kept moist.

Containerized seedlings are less susceptible to freezing or drying out, but they too can be damaged by careless handling. If they are transported in a closed truck, they can become overheated, especially when planting in late spring and summer. On the other hand, if they are transported in an open vehicle, they can become desiccated or damaged in the wind. Seedlings should be transported in a way that provides good ventilation and doesn't allow too much wind directly on the leaves.

Transplanting seedlings or saplings from another area onto a project site is also a possibility. Depending on size, they can be transplanted by using hand tools, backhoe, or treespade. Mortality or stunted growth from shock can be very high if the relocation is not done very carefully. The best time to transplant is during the dormant season, which in the Willamette Valley is usually November to mid-March. The roots of larger transplants (>2 inches basal diameter) should be balled and bagged, or placed in a burlap-lined wire basket if a treespade is used, before transporting. Smaller transplants can be transported without being placed in bags, as long as their roots are protected from drying out. If possible, transplants should be taken from sites that are similar to where they will be planted, i.e. from open sites for those that will be planted in the open, and shaded sites for those that will be planted in closed areas. An advantage to using transplants is that understory plants and seed are frequently also transplanted with the soil around the roots. Conversely, the soil may also contain unwanted weeds.

Some native understory plants can also be propagated by transplanting from other sites. Many of the shrubs, bunch growth-form grasses, and perennial forbs can be moved this way. Some species that can be transplanted are pearly everlasting, wild ginger, bunchberry, Pacific bleeding heart, woodland strawberry, false Solomon's-seal, Columbia brome, beaked sedge, California oatgrass, tufted hairgrass, and blue wildrye. Refer to the publication *Propagation of Pacific Northwest Native Plants*³⁴ for additional information on native species that can be propagated by transplanting. Remember permits are required to remove plants from public lands. See Appendix G for permit information.

Cuttings of stems or short lengths of young shoots can be used to propagate a number of bottomland hardwood and riparian forest poplars, and willows have traditionally been produced from cuttings because they root easily and their very small seeds are hard to handle and do not store well. There are three types of cuttings: hardwood cuttings that consist of mature tissue of the previous season's growth and are collected during the dormant period; semihardwood cuttings that consist of actively growing tissue; and softwood or herbaceous cuttings that are collected from the soft, succulent new shoots of woody plants during the growing season.

Because they involve actively growing materials, the last two must be used quickly before they dry out.

Stem cuttings have an inherent polarity and will always produce shoots at the distal or distant end nearest the bud, and roots at the proximal end (nearest the main stem or root system). To distinguish between tops and bottoms, cut the bottoms at an angle, which not only insures that the cuttings are planted right side up, but makes them easier to stick or plant. Some species such as cottonwood will start from horizontally placed cuttings. A common method of blocking or slowing runoff in small ditches is placing bundles of cottonwood cuttings across the ditch (see photo below) As the cuttings grow and take root, they create a permanent water barrier.



Figure 10. Bundle of cottonwood cuttings placed in a small ditch to slow run off and ultimately generate riparian vegetation through hardwood cutting. Photo by Rick Barney, NRCS

Hardwood cuttings of some deciduous species are relatively easy to root. Willow, cottonwood, and red osier dogwood can be collected as long whips and then cut into proper lengths for sticking. The basal cut is typically made just below a node, where roots form more readily. The cuttings are bundled and secured with rubber bands and stored under refrigeration at slightly above freezing to keep them dormant until needed. Cuttings can be soaked in a surface sterilant or fungicide to retard storage molds and decay of the cut surfaces. Placing the bottoms of the cuttings in moist sawdust or wood shavings while in the cooler will promote callusing and speed up root initiation when planted.

Bottomland and riparian forest plants that can be propagated by hardwood cutting are: Scouler willow, Pacific Willow, cottonwood, blue elderberry, cascara, Pacific ninebark, and red-osier dogwood. Species that can be propagated by softwood or herbaceous cuttings are twinflower, vine maple, kinnickinnick, snowbrush, red-osier dogwood, oceanspray, mockorange, red elderberry, red alder, bitter cherry, chokecherry, and Scouler willow. Baldhip rose can be propagated by semi-hardwood cuttings, and root cuttings can be used to propagate Oregon grape and serviceberry. The publications *Propagation of Pacific Northwest Native Plants*,³⁴ *Silvics of North America, Hardwoods*,⁷⁶ and *Willamette Valley Native Plants Along Your Stream*⁷² provide good reference information on propagation by cuttings.

Natural Vegetation Establishment is an attractive alternative for restoration because it costs nothing. Also, the plants that become established on the site by this method should be well adapted to the site. If conditions are right, natural regeneration can be quite rapid. Best conditions for natural regeneration are sites no farther than about 75-100 yards from existing forests. A commonly applied rule of thumb is that natural regeneration will succeed without intervention in areas that are no further from an existing forest twice the height of the dominant canopy trees. The biggest disadvantage of natural regeneration is lack of control over species composition. It may be necessary to thin some species over time to allow slow-establishing species to get started. A second disadvantage is the longer time period required for establishment of tree cover in old field restoration. Natural regeneration is likely to go through a successional process where the site is first invaded by annuals; then perennials; then shrubs and light seeded shade-intolerant species; and finally heavy-seeded shade-tolerant tree species. This process could take from 10 years to many years, depending on local conditions.

Seedling Protection. New plantings are vulnerable to damage from animals. See Seedling Protection in the Oak Woodlands chapter, page 9, for recommendation on how to protect seedlings.

MAINTENANCE. Restored areas will require maintenance. Exotic invasive species have become well established throughout the valley and are a continual threat to restored habitats. Tree shelters, fences, and water control structures also require some upkeep. See pages 9 and 10 in the Oak Woodlands chapter, and pages 28 and 37 in the Wetlands chapter for maintenance information.

SPECIAL CONSIDERATIONS FOR RIPARIAN AREAS

Riparian areas are defined as the strip of land bordering a stream, lake, or wetland, plus the zone influencing this

area.⁸⁷ While riparian areas are very limited, they play such an important role in the landscape that they have been called the aorta of an ecosystem.⁸⁹ This importance is demonstrated by the number of wildlife species that use riparian and wetland habitats during some portion of their life. Of the total of 414 species of amphibians, reptiles, birds, and mammals in Oregon and Washington, 359 or 87% frequent or are dependant upon these habitats.³⁸ Approximately 29% of these are obligates, that is they are dependant upon the riparian zone.⁹¹ In parts of the western United States more than 10 times as many birds use riparian zones during migration as any other habitat.⁷⁸

Floristically and structurally, the riparian forests of the Pacific Northwest are the most diverse communities of the region.⁹⁰ As many as 107 different vascular (does not include mosses, lichens and other lower plants) plants have been documented in riparian areas in the Willamette National Forest.⁹² The vertical structure is also diverse, with at least four layers of vegetation: grass and forb ground cover, low shrubs, high shrubs or subcanopy, and canopy.

Riparian areas are also horizontally diverse. Based on moisture, there typically are three zones (Fig. 11): Zone 1, which is inundated mid-short term and supports hydrophytic (living in water or saturated soil) vegetation; Zone 2, which is seasonally flooded and supports a mixture of hydrophytic and upland vegetation; and Zone 3, which is influenced by the moisture in Zones 1 and 2 but supports predominantly upland vegetation.

Riparian areas in the Willamette Valley generally suffer from one or more of the following degradations: lowered water tables due to straightening and hardening of stream channels and banks; channel erosion and cutting; livestock grazing; clearing and removal of vegetation; and invasion



Figure 12. Blocked ditch with sticks. Old pasture drainage system blocked with low soil, rock, and wood dam and stabilized with live willow cutting stakes. Photograph taken after one winter rainy season. Photo by Rick Barney, NRCS

by exotic invasive vegetation. To successfully restore a riparian area, these degradations must be corrected.

CHANNELING AND BANK HARDENING, CHANNEL EROSION AND CUTTING.

Restoration of large-scale channelization and rip rap, common along much of the mainstem Willamette River and its major tributaries, is beyond the scope of this guide. Restoring these types of areas would require extensive engineering, large equipment, and permits that likely are either difficult to obtain or not available. Restoration of smaller streams and ditches is possible, although they too will require some planning and possibly heavy equipment. For projects requiring more engineering, design, and costs than the landowner is willing to commit to, contact the local watershed council or NRCS office for advice and assistance (Appendix D). Riparian restoration is a high priority in Oregon and both organizations typically have grants available for these types of projects.

Channel Restoration. Restoring hydrology and riparian habitat in smaller streams, channelized or deeply eroded streams, and ditches often requires some type of instream work to slow flow and facilitate bed build-up. This is a good time to also consider instream habitat improvement. While most of the following channel restoration methods will also improve habitat in the stream, considerably more can be accomplished with little additional effort or expense. Landowners and/or restorationists are urged to review several good sources of information for instream habitat improvement:

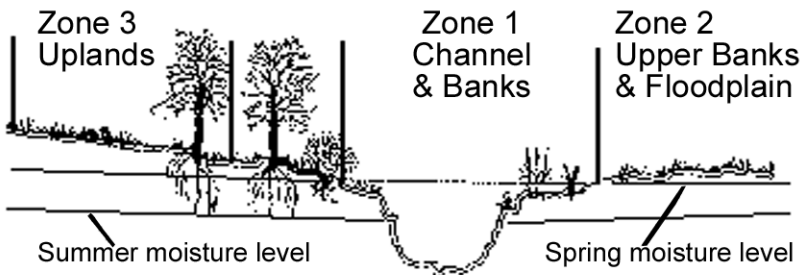

Figure 11. Riparian zones based on moisture. Image from USDA, NRCS Plant Materials³¹

*Stream Habitat Improvement Handbook, California Salmonid Stream Habitat Restoration Manual*⁹⁴ (www.dfg.ca.gov/nafwb/manual.shtml) or *Stream Corridor Restoration, Principles, Processes, and Practices*⁹⁵ (www.usda.gov/stream_restoration).

Channelized or deeply eroded streams and ditches can be restored using the recommendations on page 21 in the Wetland chapter. By using these methods to slow runoff, pools and meanders will usually form and the water table

will rise as soils become saturated. This provides an environment favorable for riparian plants, which can be planted using the methods discussed on page 44 in this chapter. Figure 12 demonstrates a drainage ditch that has been blocked and planted with willow cuttings.

Hydrology in eroded, deeply incised channels can often be improved by installing large rock and stump root wads that slow flow and raise the water table. The root wads form large woody debris, which is an important component of

Box 7

STREAM CHANNEL TYPES APPROPRIATE FOR ROOT WAD AND BOULDER PLACEMENT⁹⁴

General description	Entrenchment*	Slope/gradient ⁺	Width/depth ratio [‡]	Substrate [†]	Structure suitability
Moderate entrenchment and gradient, stable banks, cobble channel	1.4 – 2.2	2-4%	>12	Predominate cobble	Excellent
Moderate entrenchment and gradient, stable banks, gravel channel	1.4 – 2.2	2-4%	>12	Predominate gravel	Excellent
Moderate entrenchment and gradient, stable banks, silt/clay channel	1.4 – 2.2	2-4%	>12	Predominate silt/clay	Fair
Low gradient, meandering, alluvial channels with broad, well defined floodplain, cobble channel.	> 2.2	<2%	>12	Predominate cobble	Good
Low gradient, meandering, alluvial channels with broad, well defined floodplain, gravel channel	> 2.2	<2%	>12	Predominate gravel	Good
Wide, entrenched, meandering channel with cobble substrate	Well entrenched <1.4	<2%	>12	Predominate cobble	Fair
Wide, entrenched, meandering channel with silt/clay substrate	Well entrenched <1.4	<2%	>12	Predominate silt/clay	Fair
All other types of channels					Poor to not suitable

* Ratio between flood-prone channel width and bank-full width. Entrenched = ratio <1.4, i.e. flood-prone channel not much wider than bank-full width or deep channel with steep sides. Moderately entrenched = ratio 1.4 – 2.2, i.e. flood-prone channel somewhat wider than bank-full channel. Slightly entrenched = ratio >2.2, i.e. wide flood prone channel and shallow (possibly braided) bank-full channel.

⁺ Slope/gradient is measured over a distance of at least 20 bank-full channel widths.

[‡] Ratio of bank-full width to bank-full average depth, e.g. wide, shallow channel has high ratio. Low ratio (deep, narrow channel) = <12, moderate – high ratio (shallower, wider channel) = 12 – 40, very high (shallow, wide channel) = >40

[†] The most common particle found on the bed of the stream. Classified by maximum diameter: >10” – boulder; 2.5-10” – cobble; 0.08-2.5” – gravel; <0.08” – sand; silt/clay – N/A; bedrock – N/A.

small streams, particularly in the Pacific Northwest where woody debris is historically more abundant in streams than any other part of North America.⁹³ Large woody debris slows flows, forming pools and waterfalls, and affects channel width and depth. It facilitates deposition of sediment and accumulation of organic matter, which in turn provides substrate for plant establishment, ultimately raising the channel bed. Debris also provides important habitat for fish.

Water surface slope/gradient, channel width and depth, channel entrenchment, and dominant substrate all determine the feasibility of stream restoration and appropriate type of restoration. Typically steep, narrow, high-energy (flow) streams with unstable substrate are not suitable for restoration using root wads or large rock. The high-energy flow will usually "blow out" structures or rapidly erode around them, particularly in sandy or clay soils. Streams most suitable for root wad or boulder placement are low/moderately entrenched, low/medium gradient, have stable banks, and have a dominant substrate of cobble or gravel.

In addition to hydrology and substrate, additional factors, including accessibility, tree species, and root wad availability influence the practicality of restoring stream hydrology with root wads. Streams must be accessible to vehicles transporting root wads and equipment to unload and place them. An excavator with a "thumb" is ideal for moving and placing roots. A backhoe will also work. Hardwood or

cedar root wads are preferable because they last longer than softwoods such as Douglas fir. Root wad availability is also a factor. Douglas fir roots may be more available than preferable tree species and therefore more practical. A good source of information on root wad availability is the local soil and water conservation district or watershed council (Appendix D). They have the best knowledge of what is going on in the area and who might be clearing stumps.

In all but the smallest streams and ditches, root wads will need to be secured to prevent high water from moving them. Root wads with sections of the trunk attached are preferable because they are easy to anchor. They can be secured by attaching them to bedrock, boulders, or stable logs with galvanized or steel cable using steel rebar, expansion bolts, or polyester resin adhesives. These methods of attachment require rock-drilling equipment, polyester resin adhesives, and steel cable working tools — items most landowner do not have or wish to work with. Consequently, only the stable log, or deadman, anchoring technique will be discussed in this guide. For those wishing to use the other techniques, a good description of them can be found in a California Department of Fish & Game publication, *California Salmonid Stream Habitat Restoration Manual*⁹⁴ (www.dfg.ca.gov/nafwb/manual.shtml).

A deadman anchor (Fig. 13) for a root wad can be created by burying an anchor log on the bank and attaching the root wad to it with steel or galvanized cable. The anchor log must be buried at least three feet deep on the stream bank above bankfull flow. It is placed in a pit with several anchoring cables attached. The cables extending from the anchor log are placed in narrow trenches dug down to the instream root wad. After attaching the cables to the root wad, the pit and trenches are back-filled and compacted. Cables are attached to the root wad by either drilling holes in the trunk and threading the cables through, or wrapping them around the wad/trunk. If they are wrapped around the trunk, bark should be removed and a shallow notch should be cut for the cable to lay in. Final attachment of the cable involves doubling the cable ends over the cables and attaching the two together with clamps. Three cable clamps should be used per cable, spaced about "3-fingers" apart on half-inch cable or "4-fingers" apart on 5/8-inch cable.

Large boulders can also be placed in an incised ditch or channel with root wads. These diversify structure and help anchor the roots. Angular quarry boulders are preferable because they are more stable under high stream flows. The greatest disadvantage to using boulders is the difficulty of transporting and placing them due to their weight. An approximation of weights for boulders is:

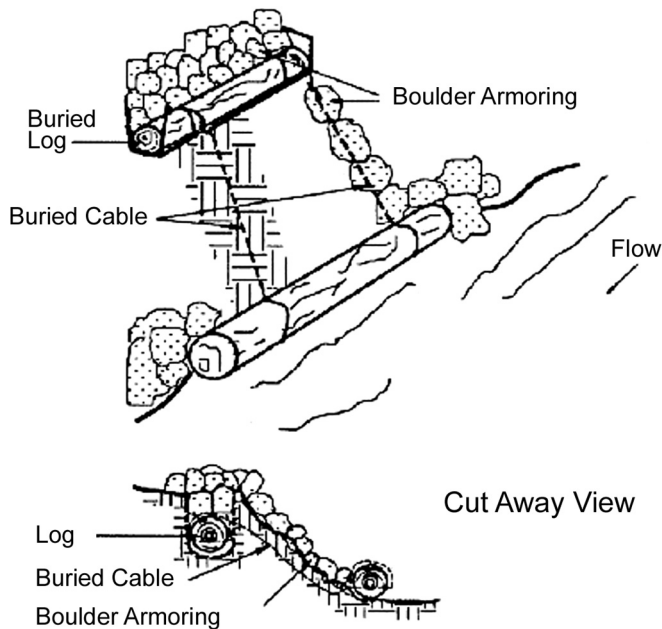

Figure 13. Deadman anchor. Used to hold logs and root wads in place in a stream. Image from California Dept. of Fish & Game.

BOX 8	
APPROXIMATE WEIGHT OF BOULDERS	
Diameter (feet)	Weight (lbs.)
2	625
3	2,115
4	5,000
5	9,800

Bank shaping (Fig. 14) may be appropriate for some incised ditch and small stream channels as well as ponds with steep banks. It involves excavating and filling the raw, eroded stream bank or steep pond sides to a side slope that is suitable for the site. Suitability criteria include soil materials, moisture conditions, planned vegetation, bankloading conditions, and hydraulic exposure of the site. Soil materials refers to soil texture, fertility, salinity, and pH. Unless altered by human activity, alluvial soils (floodplain soils) typically are fertile and their chemical make-up appropriate for supporting vegetation. If any of the soil characteristics of a project site are suspected to be a problem, the soil should be tested. The local NRCS, soil and water conservation district of extension office can provide assistance with soil testing (see Appendix D).

Two moisture conditions are of concern for bank shaping. First, soil moisture or hydraulic exposure should not be so high as to cause soil slumping after banks are shaped. If water is running out of the cutbank or springs are abundant, bank shaping may not be appropriate for the site. If the site is very wet, seek the advice of a hydrologist or engineer from the NRCS. A second moisture concern is adequate soil moisture to support stabilizing vegetation after bank shaping. Irrigation may be necessary until plants become established.

Bank loading refers to the pressure that is placed on a bank from above and behind. On relatively flat surfaces loading is not a major factor. However, in situations where banks are adjacent to hill sides or steep slopes, bank loading can be great enough to cause bank failure and slides after the soil is disturbed by shaping. Hydraulic pressure can increase the tendency of soils to slip. Saturated or very wet soils adjacent to steep slopes will slip at lower bank loading than dry soils. Bank shaping should not be used where bank loading and / or hydraulic pressure are high.

The planned vegetation suitability criteria refers to the appropriateness of plant species to be

used for revegetation after bank shaping. In most cases, the plant species listed as riparian species in Appendix A are appropriate for revegetation of stream banks. Fast growing species that will rapidly bind the soil are preferable. See the following section for recommended species and methods of bank stabilization.

Schedule shaping work to end during the planting windows for the plant species selected for revegetation and during periods that will not interfere with key aquatic species reproduction. **Remember, permits may be required for instream and bank work.** Shape the bank to a 4:1 to 2:1 slope. If the latter slope is used, terracing is recommended. Shaping can be done with a tractor and blade, backhoe, or other earth moving equipment. Steeper slopes should be stabilized using the brush-mattressing technique discussed below.

Streambank Stabilization or Bioengineering. Streambank erosion can be a serious problem. Using vegetation to stabilize and minimize erosion problems on stream banks is less expensive than repairing erosion-caused damage after the fact. Techniques to stabilize streambanks work by either reducing the force of the flowing water, by increasing the resistance of the bank to erosion forces, or by a combination of both.

The following techniques primarily increase the resistance of the streambank by binding the soil with root systems and growing a vegetative cover. They are known as soil bioengineering. Once established, this living material effectively controls water runoff and wind erosion, filters soil from runoff, intercepts raindrops, improves water percolation into the ground, and moderates ground and water temperature.

The live staking method uses dormant, living woody cuttings of species able to root quickly in a streamside environment. Species such as willow, cottonwood, and red-osier

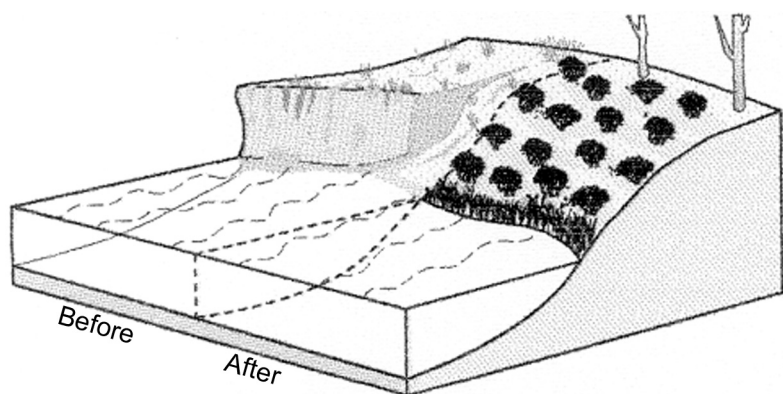

Figure 14. Bank shaping and planting. Image from the NRCS National Engineering Handbook.

dogwood work well as cuttings. This method is appropriate on stream banks of moderate slope (4:1 or less) and original soil. This type of planting is also appropriate for pond banks (Fig. 15, below). It is most effective on banks that are frequently moist or wet. The cuttings need to be large enough in diameter and long enough to be driven into the ground as stakes, usually 1/2-2 inches in diameter and 2-3 feet long. They must not be allowed to dry out and should be installed the same day as collected. Side branches should be cleanly trimmed and the bark left intact. The top cut should be level and the bottom cut at an angle to drive easily into the ground. The buds are oriented upward when planting or sticking. If cuttings are obtained from nearby plants, there is little to no cost associated with this type of planting.

Conventional plantings offer a greater selection of plant materials. See Planting Seedling Trees and Shrubs on page 43 for more information.

Live fascines, also called wattles, are used to protect banks from washout where water levels fluctuate only moderately. A fascine is a long (10-20 foot), sausage-shaped bundle of live, dormant branches. The branches used to make the bundle should be at least 4 feet long. The butt ends all face the same direction and the branches are bound in an overlapping pattern to create the full length of the fascine. Bundles are 6-8 inches in diameter and tied with natural, undyed baling twine. As with lifestaking, live fascines are made of species that root easily such as willow, cottonwood, or red-osier dogwood. Working up the slope, live fascine bundles are placed in trenches and held in place by dead stakes. The soil is foot tamped in place along the sides of the bundles and live stakes are installed on the downslope side. Placement must be secure so water cannot wash soil out

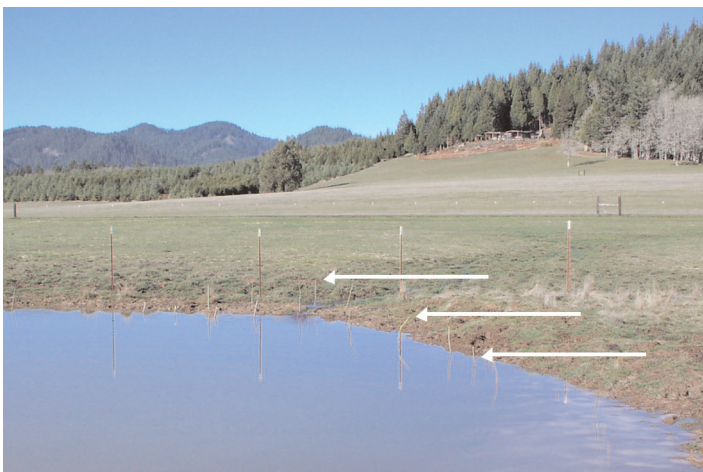

Figure 15. Pond with reshaped banks to reduce slope, planted with live staked willow and cottonwood (arrows).

Photo by Rick Barney, NRCS.

from underneath the bundles. The resulting effect is a series of short slopes, stairstepped and separated by the fascines.

Branch-packing (Fig. 16, next page) is a technique for repairing an area of washed-out stream bank such as a hole, gully, or slumped area. The damaged area is prepared and then alternately layered with live branches 1/2-2 inches in diameter and 3-5 feet long and soil. The section to be branch-packed is cleaned out and sloped toward the bank. Wooden stakes are driven vertically into the washout, 4 feet deep and 1 foot apart. Then a thick layer of branches is pressed between the stakes at the bottom of the washout. These are covered with 8-12 inches of soil. This alternating procedure is continued until the entire washout is filled in. As layers of branches proceed upward the basal ends are placed lower in the soil than the growing tips. This technique is best limited to washouts no more than 5 feet wide and 4 feet deep. This is an acceptable method of bank stabilization after shaping.

Brush-layering is similar to branch-packing. It can be used on slopes up to 2:1 in steepness and no more than 15 feet high. With this method live branch cuttings are oriented more or less perpendicular to the slope contour. The cuttings, with their side branches intact, are placed in small "benches" excavated into the slope. Each bench step is 2-3 feet wide and spaced 3-5 feet apart. Starting at the bottom of the slope, each lower bench is backfilled with soil from the next higher bench. Bare earth between the "steps" is mulched and seeded. This technique breaks up the slope length into a series of shorter slopes. This is an acceptable method of bank stabilization after shaping.

A modification of several of the previous techniques is brush-mattressing (Fig. 17, next page). It is fairly involved and labor-intensive to construct, but benefits are both immediate and long-term. After grading is completed, a live fascine is placed at the toe of the slope. Upslope from the fascine a grid of alternating dormant and dead stakes are driven into the ground. Around these stakes a layer of live, dormant untrimmed branches are laid to create a "mattress." Soil is then spread over the branches until they are partially covered. Wire is strung from dead stake to dead stake, creating a "mesh" to hold the brush mattress in place and tightly to the ground. The mattress provides immediate protection from erosion of the slope while the rooting and subsequent growing bushes from the fascine, the lifestakes, and some of the branches in the mattress provide long-term benefits. This is the preferred method of bank stabilization after shaping.

LIVESTOCK GRAZING

Livestock grazing of riparian areas is probably one of the primary sources of degradation in the Willamette Valley, ranging from little damage resulting from light grazing to

complete loss of understory layers and plant reproduction due to heavy grazing. Stream or pond bank damage can also be extensive when livestock are allowed unlimited access. Restoration of these areas starts with grazing management to allow for vegetative recovery.⁹⁵ Natural vegetation recovery is most desirable because this type of vegetation maintains itself in perpetuity, allows stream to function in ways that artificial structures cannot, and provides a natural resiliency to withstand a variety of environmental conditions.

The compatibility of grazing with riparian recovery and management is debatable. Some authorities consider grazing a compatible use of riparian areas,⁹⁵ while others maintain excluding livestock from riparian areas is the only grazing strategy that consistently results in the greatest rate of vegetative recovery and the improvement in riparian function.¹²⁵ This guide recommends that livestock be fenced out of riparian areas. Fencing can be very expensive and require considerable maintenance, however, there are several grants available to help defer these costs. Contact the local soil and water conservation district, NRCS office, or watershed council (Appendix D) for assistance in identifying the grant appropriate for your needs and applying for that grant.

VEGETATION RECOVERY

If planting is part of the scheme for restoring riparian vegetation, see the above section entitled Seeding or Planting in this chapter.

A final reminder, remember that working in streams in Oregon requires a Removal-Fill permit from Division of State Lands and a Section 404 permit from the U.S. Army Corps of Engineers. If species listed as threatened or endangered under the federal Endangered Species Act are present additional permits may be necessary. For assistance in determining what permits are needed to restore the hydrology and banks of a stream contact the Oregon Department of Fish and Wildlife, Lands Resources Program at 503-947-6301.

Cross Section Not to scale

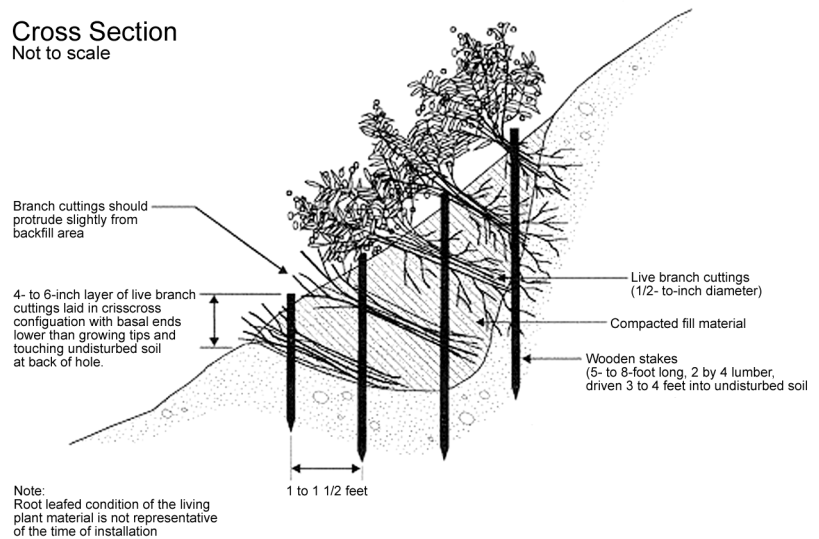

Figure 16. Branch-packing.
Image from the USDA NRCS Engineering Field Handbook.

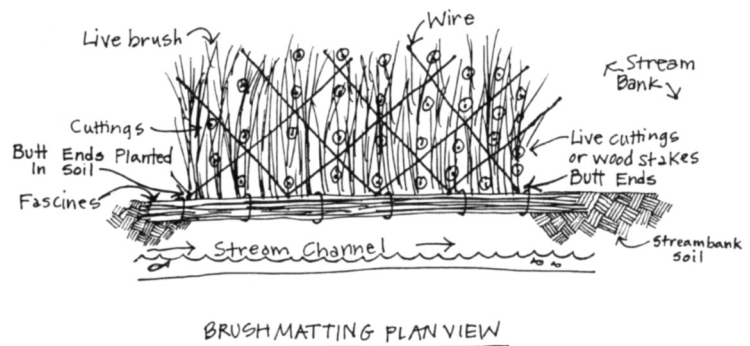

Figure 17. Brush matting slope protection.
Image from *Restoring Streams in Cities* by Ann L. Riley.
Excerpted by permission of Island Press, Washington D.C.

Grasslands and Prairie

Prior to European settlement much of the Willamette Valley was a mosaic of dry and wet prairies or grasslands⁴ apparently generated and maintained by fire.¹⁰²

Wet prairies occurred on areas with heavy clay soils, and dry prairies were common on well-drained soils. While the native vegetation of the prairies remains somewhat uncertain, sketchy historical records suggest that wet prairies, typified by such plants as tufted hairgrass and camas, occurred on low areas with soils saturated by heavy winter precipitation and periodic flooding. Dry prairies, characterized by such plants as Roemer's fescue, California brome, and rose checkermallow, occurred on well-drained upland areas. Both types of prairies supported a unique wildlife assemblage that included Oregon's state bird, the western meadowlark, as well as short-eared owls, black-tailed jackrabbits, camas pocket gophers, gray-tailed voles, burrowing owls, vesper sparrows, common nighthawks, sharp-tailed snakes, western pond turtles, and a host of invertebrates (see Appendix H for a more comprehensive list).

Today, urban and rural development, fire suppression, and intensive cultivation have resulted in the loss of over 98% of the native grasslands.² While it may be impractical to recreate large amounts of this habitat in its native form, it is possible to convert fallow fields, lightly grazed pastures, and uncultivated "weedy" areas into habitats with structure, composition and function more like grasslands.



Native seasonal wet prairie on William L. Finley National Wildlife Refuge.
Photo by Bruce Campbell.

Before starting a restoration project, it is important to understand the role of structure and function in the ecology of a grassland community. Structure refers to the horizontal and vertical makeup of the community, such characteristics as the height of the vegetation or vegetative layers (vertical structure) and amount of ground surface covered or bare (horizontal structure). Function refers to how structure

provides the characteristic purposes or roles of a grassland, such as — in the case of wildlife — food, water, and shelter. Both structure and function are relative conditions. The structure and function of a fallow commercial grass field are more like a native grassland than those of an actively cultivated field, but not as much as a pasture with mixed native and exotic grass species. In turn, the structure and function of a pasture is not as much like a native grassland as a pasture comprised of native grasses.

Many wildlife species inhabiting grasslands are more sensitive to habitat structure and function than vegetative species composition (see exception, next page). This is illustrated by the eight Oregon Sensitive Species that are associated with grasslands. All have habitat structural requirements, but none are known to have specific plant species requirements. For example, the western meadowlark, the icon of grasslands, will use habitats with a wide range of vegetation heights and densities, although they are most common in areas with a high percentage of grass and sedge

cover >5 inches tall.¹⁰⁰ Habitats with suitable structure can be found in idle native and introduced-species grasslands, native and introduced-species pastures and hay fields, road rights-of-way, field edges, cropland, wet meadows, orchards, and riparian areas.

Because grassland habitat structure, function, and value as wildlife habitat are relative, so is restoration of this habitat. Habitat quality, in terms of structure, function, and wildlife value, is a continuum ranging from non-existent or very poor to excellent, such as that found in pure undisturbed native grassland. Habitat restoration involves moving conditions on a site along this continuum toward higher quality habitat, not necessarily completely restoring native grasslands (Fig. 1, page 4).

There are obvious exceptions to the lack of species composition specificity in grasslands. The Fender's blue butterfly (*Icaricia icarioides fenderi*), a rare butterfly protected under the federal Endangered Species Act, is a perfect example. It requires a specific grassland plant species to host its young. Species such as Fender's blue butterfly demonstrate why plant species composition should also be considered when restoring grasslands and prairies.

RESTORING PRAIRIES AND GRASSLANDS

PROJECT PLANNING

The restoration plan will depend upon the characteristics of the site, landowner objectives and resources (time, funding, labor).

PROJECT GOALS. For properties enrolled in the Wildlife Habitat Conservation and Management Program, goals are established in the required plan. Common goals include maintaining or enhancing existing grasslands, reestablishing a grassland, or establishing a grassland or prairie. The landowner or cooperating agencies may also wish to establish more specific goals, such as a list of plant species to be maintained or established, number of specific species occurring per given area, or specific management actions to benefit wildlife species. *The Tallgrass Restoration Handbook*¹¹⁰ and *Techniques for Wildlife Habitat Management of Uplands*¹⁰⁹ are recommended reference sources for grassland restoration.

The following project planning components will primarily address grassland establishment or reestablishment. However, most are also valid considerations for maintaining or enhancing existing grasslands. For example, the influence of soil texture and drainage in determining what species will be appropriate for an area is just as important in enhancing a

grassland as it is in establishing a grassland. It would be a waste of time and money to attempt to enhance a dry, upland fallow-field grassland by seeding or planting wet prairie species.

SITE CHARACTERIZATION AND EVALUATION. Project size is important in evaluating a site. When possible, bigger is better. Large sites support larger and more genetically diverse populations of species; permit a landscape perspective, i.e. a variety of grassland types; and provide habitat for animal species that need larger areas, such as the western meadowlark, which requires up to 20 acres per family.¹⁰⁰

The value of small "postage stamp" grasslands, however, should not be underestimated. Areas as small as one-quarter acre have been shown to harbor a diverse community of grassland invertebrates, including rare species that don't occur in adjacent agricultural fields. Small restoration projects in lawns, parks, schoolyards, and business complexes can harbor a substantial number of native prairie animals and plants, and provide educational values for valley residents.

Shape is also a consideration since it determines the edge-to-area ratio. The smaller this ratio, the easier it is to control the unwanted influences of adjacent land uses. In general larger circular or square sites are better than narrow corridors because they have smaller edge-to-area ratios.

Soils play an important role in the grassland community. Prairies establish well on nutrient-poor soils; in fact, rich soil favors weeds over prairie species in the early years of restoration. The addition of organic material or fertilizer is usually not advisable in a restoration project. Soils, along with moisture and amount of light, will determine the species composition of the grassland plant community.

Soil texture and drainage are important. These site characteristics provide the best indication of what species will be appropriate for an area. Texture can be determined by rubbing soil between your thumb and fingers. Sandy soils are very gritty and don't stick to your fingers. Loams have a small gritty component, are slightly sticky, and have a smooth flour-like feel because of the presence of silt. Clay soils are more sticky, but some have enough silt to give them a flour-like feel. Wetness can usually be determined by simple observation: is the area low-lying and seasonally flooded, or does it frequently have standing water for a day or two after heavy rains? Also see checklist on page 18, *Are or Were There Wetlands on my Land?* for assistance with identifying wetlands. If the area appears to be wet, consider planting wet prairie plant species, even if the soil is sandy. Dry grassland species are best for well drained sandy soils and shallow loamy soils on ridges or slopes, particularly if the aspect of the slope is south or west. Gently sloping or level sites with

loamy soil, or clay soil containing some organic material, are suitable for mesic species (species requiring or tolerating moist conditions). Heavy clay soil with little organic matter is tolerated by only a few species. It can be improved by adding organic matter or topsoil, or by growing a mix of clay-tolerant species.

Presettlement and existing vegetation should also be considered when selecting plant species for the restoration. The general presettlement vegetation or plant communities for a project area can be identified from the Willamette River Basin planning atlas presettlement vegetation map.²⁴ Identification of current vegetation is a critical, often overlooked, step in restoration planning. It is important to determine whether a significant component of native grassland species are present so that it can be protected and encouraged. Weed species, such as reed canary grass, Canada thistle, purple loosestrife, and quack grass, will determine restoration techniques. Many of these can be controlled by active management, but it may be easier to rid the site of them before planting.

There are two general seeding methods for grassland restoration. One, referred to as interseeding, broadcasts seed over existing vegetation without cultivation. This is usually done after the area has been mowed, burned, or treated with herbicides. Advantages of this method include time and energy savings as compared to tilling, and the fact that it doesn't disturb desired species already present, and can be used in areas too wet to cultivate. The second approach is preparing a weed-free seedbed that has been carefully cultivated for planting. This technique usually gives quick results with easily established species, and seed germination and seedling survival may be better. The biggest disadvantages are the time and energy required and potential for erosion. It is also not a suitable technique for existing oak groves, where tilling would damage tree roots. Seedbed preparation, methods of seeding, and equipment will be discussed in more detail by topic later in this chapter.

RESTORATION DESIGN. "Should I cut down all these trees and restore prairie, or should I save some cherries, plant some oaks, and restore woodland?" "Do I plow up this old meadow, or plant directly into what's already here?" Choosing a grassland, woodland, or some other target community and selecting restoration strategies to develop that community require difficult choices. Yet the choices must be made before restoration can begin.¹⁰¹

If the project goal is to maintain existing grasslands or reestablish/enhance grasslands on a site in full sun with uniform soil and slope, and if the site is small enough to fit your budget and energy and can be planted with a standard mix of commercially available prairie seed, little restoration

design is necessary. Most situations are more complex. Often the land has lost its original structure, i.e. hydrology and topography. In this case, before restoration can begin, a grassland community appropriate for the site must be designed.

A good starting point in designing a grassland community for either an existing or a newly established grassland is to map the site, showing features that should be considered in the plan, such as steep slopes, soil types, shaded areas, existing or planned roads, fences, and trails. If soil and topography provide conditions for more than one prairie type (see discussion of the importance of soil texture and drainage on page 55), the next step is to map where each type does or will occur and estimate the size of the areas. To get accurate estimates, the areas can be staked and measured.

Once you have an idea of the number and size of areas with different soils, aspect, and drainage, grassland communities can be designed to fit these conditions. A couple of things should be kept in mind while designing the communities.¹⁰³ Plantings with lower percentages of forbs (20-40% forbs) and higher percentages of grasses tend to result in grass-dominated prairies in a very short time. Plantings with a higher percentage of forbs (50-60%) usually produce a more diverse prairie community with a good cover of both grass and forbs. If a planting has too many short-lived species, it will not persist. On the other hand, plantings with slow-to-establish, long-lived species require several years before anything resembling a prairie develops. Also, aggressive species can overwhelm other species and should not be planted too heavily. This is also the case for early-successional species that can stunt the establishment of slower-germinating species. To avoid these pitfalls, it is probably best to visit a native seed supplier and discuss your site characteristics, goals, and appropriate species and planting rates.

If you wish to design your own communities, lists of Willamette Valley prairie species suitable for wet and dry conditions are presented in Appendix A. Lists can also be obtained from the NRCS or local soil and water conservation district (Appendix D). A short list of those most commonly planted is in Box 9, next page.

To avoid the planting mix pitfalls, you should do some research to determine which of these species or those listed in Appendix A may be a "problem" species, i.e. aggressive, slow-germinating, etc. The Internet is a good tool for this type of research. Do a web search for each species you are considering and you will find sites that provide its natural history.

BOX 9

**COMMERCIALLY AVAILABLE WILLAMETTE VALLEY¹⁹
NATIVE PRAIRIE PLANT SPECIES**

GRASS AND GRASS-LIKE SPECIES FOR DRY UPLAND SITES	
California brome (native variety or cultivar)	California oatgrass (native variety or cultivar)
Blue wildrye	Romer's fescue
Slender rush	Prairie Junegrass
GRASS AND GRASS-LIKE SPECIES FOR MOIST LOWLAND SITES (Use at least 3 species)	
Spike bentgrass	American slough grass
Dense sedge	One-sided sedge
California oatgrass	Tufted hairgrass
Annual hairgrass	Western mannagrass
Meadow barley	Spreading rush
SHRUB SPECIES FOR DRY TO MOIST SITES (Plant less than 10% of area)	
Western serviceberry - dry	Black hawthorn - moist
Nutkana rose - moist	Clustered wild rose - moist to dry
Mock orange - dry	Oceanspray - dry
Hardhack - moist to dry	Tall Oregon grape - dry
Red-flowering currant- dry	

Once restoration is underway, monitoring changes will help decide whether the proper restoration goal or target was selected and whether work is succeeding in moving conditions toward that target. If the community is moving toward the one identified as the target, and if the natural quality (number of native species present and development of natural processes, such as nesting grassland birds) of the community is increasing, then your management is probably on track. If, on the other hand, the quality of your site is rising, but the community is turning out to resemble an oak savanna, for example, rather than the open grassland intended, or if the site quality appears to be dropping because the restoration work is eliminating the habitat of the site's rare species,

WILDFLOWERS FOR DRY UPLAND SITES (Use at least three species)	
White or common yarrow	Northern brodiaea
Leichtlin's camas	Fairwell to spring
Wild hyacinth	Woolly sunflower
Mountain strawberry	Common lomatium
Broadleaved lupine	Showy tarweed
Northern cinquefoil	Heal-all
Western buttercup	Meadow checkermallow
Rose checkermallow	Canada goldenrod
American vetch	Early blue violet
WILDFLOWERS FOR MOIST LOWLAND SITES (Use at least three species)	
Slimleaf onion	Hall's aster
Leichtlin's camas	Common camas
Bigleaf lupine	Common monkey-flower
Rosy plectritis	Northwest cinquefoil
Oregon saxifrage	Narrow-leaf wyethia

don't become discouraged. As Stephen Packard wrote in *The Tallgrass Restoration Handbook*,¹⁰¹ "Listen to the ecosystem." The initial goal reflected the best judgment with the information then available. It helped the project get started. As restoration proceeds, the ecosystem's natural inclinations and healing process will be recognized. The target can then be modified to reflect these, and "nature" can guide restoration following its own course.

On the next page is a key to assist restorationists in establishing project goals or targets for a site.¹⁰¹

KEY TO ESTABLISHING PROJECT GOALS:

1. If the land is wooded, go to 2 (if not, go to 14).
2. If trees include mature oaks, go to 3 (if not, go to 9).
3. If the ground has continuous grass or oak leaf cover so that brush can be controlled gradually through controlled burning, go to 4 (if not, go to 6).
4. If the ground cover consists of primarily native grasses and forbs, consider **Restoration Option A1** or **A2** (if not, go to 5).
5. If ground layer consists largely of weeds, dry leaves, or bare ground, consider **Restoration Options B1** or **B2**.
6. If insufficient fuel accumulates to sustain fire adequately or controlled burning is not an option, consider **Restoration Options C1, C2, or C3** (if not, go to 7).
7. If the restoration goal is savanna, see Oak Woodlands chapter (if not, go to 8).
8. If restoration goal is prairie or grasslands, clear all trees and exotic or aggressive brush. Go to 12.
9. If many of the small trees are oaks, go to 10 (if not, go to 11).
10. If restoration goal is savanna or woodland, see Oak Woodlands chapter. If restoration goal is prairie or grasslands, clear all trees and exotic or aggressive brush. Go to 12.
11. If few or none of the trees are oaks and the restoration goal is prairie or grasslands, clear all trees and consider **Restoration Option J**.
12. If the land is not wooded and the vegetation (other than brush) consists principally of native grasses and forbs, go to 13 (if not, go to 15).
13. If plant diversity (variety) is good and desired or rare plant species are present, consider **Restoration Option D** (if not, go to 14).
14. If plant diversity is poor or desired or rare plant species are rare, consider **Restoration Options E1** or **E2**.
15. If vegetation is a diverse stand of perennial forbs (i.e. the site is an "old field"), consider **Restoration Option F** (if not, go to 16).
16. If the vegetation is primarily annual weeds (such as conditions often found on fallow recently tilled fields), or a dense stand of undesirable species (weeds such as reed canary grass, commercial rye grass, orchard grass) consider **Restoration Options F** or **G** (if not go to 17).
17. If the soil is bare and weed threat low, consider **Restoration Option H**.

RESTORATION OPTIONS A — H

A1. WOODLAND AND SAVANNA MANAGEMENT: Burn or mow one-third of the site every spring or fall on a revolving schedule. Mow around desirable trees. Remove problem weeds. This option requires minimal work if all goes well and there is no danger that some inappropriately planted species will dominate the site as there is in A2. See the Oak Woodlands chapter for details.

A2. WOODLAND AND SAVANNA MANAGEMENT WITH INTERSEEDING: Manage as in A1 except in addition, remove weed trees (volunteer fruit trees, hawthorn, and ash) and thin desirable native trees such as Oregon white oak where dense tree or shrub cover prevents natural establishment of ground cover or tree reproduction. Interseed with appropriate grass and forb seed immediately. This option has a strong advantage in that it gives native species a jump on weeds. Be careful to open up only as much ground as you can replant. Experiment for a couple of years to see how much area you can handle, considering how much seed can you gather or obtain and how dense you need to plant. Remember, the thinner seed is planted, the larger the acreage you can plant and the worse the weed problem will likely be. If you try to restore too large an area and can't handle the weeds, then you may have a persistent weed community for a considerable time and the native seed may have been wasted. Weedy or aggressive species can prevent desirable natives from becoming established when they are planted too thin. However, few weeds can compete once a dense and diverse native turf has been formed. See the Oak Woodlands chapter for details.

B1. DEGRADED WOODLAND MANAGEMENT (1): Follow option A1 on some test plots for 2-3 years to determine whether natural vegetation will return and gain control. A native seed bank may or may not be present in the soil. Plants may also emerge from shade-suppressed rootstock. Be careful — weed problems that develop in the absence of seeding may be severe for a decade or longer. If native vegetation does not regain control, manage as A2. See the Oak Woodlands chapter for details.

B2. DEGRADED WOODLAND MANAGEMENT (2): Manage as in A2. See the Oak Woodlands chapter for details.

C1. OAK RESCUE: Control weed tree species in order to encourage oaks; as adequate fuel accumulates, begin restoration A1, A2, B1, or B2 as appropriate. This method is simple and straightforward, particularly if large numbers of young oaks are already present. A disadvantage is the very long restoration time scale (many decades). See Oak Woodlands chapter for details.

C2. GRADUAL WOODLAND RESTORATION: Control weed tree species except as necessary for sufficient shade to provide good growing conditions for herbs of dense woodlands. Plant seed of common herbs if necessary. See Oak Woodlands chapter for details.

C3. SAVANNA RESTORATION: Remove all weed trees and thin oaks, if present, to a density of 3-5 per acre. Plant open savanna or prairie seed in areas too bright to sustain woodland species. Maintain site with fire or late summer mowing. See Oak Woodlands chapter for details.

D. PRAIRIE MANAGEMENT: Burn or mow. Clear exotic or aggressive brush if necessary. If some desirable native species are missing, or present only in very low numbers, interseed. See this chapter for details.

E1. PRAIRIE RESTORATION THROUGH INTERSEEDING: In late summer or early fall, burn, mow — or in severely weed infested situations — treat with herbicides and sow seed of native species. Sod with desirable natives may be salvaged from areas being destroyed. Cut and remove dominant vegetation when it is in bloom, or even twice during a growing season if needed to prevent loss of new seedlings from heavy shading. Interseed with appropriate grass and forb seed immediately. This option has a strong advantage in that it gives native species a jump on weeds. Be careful to open up only as much ground as you can replant. Experiment for a couple of years to see how much area you can handle, considering how much seed can you gather or obtain and how dense you need to plant. Remember, the thinner seed is planted, the larger the acreage you can plant and the worse the weed problem will likely be. If you try to restore too large an area and can't handle the weeds, then you may have a persistent weed community for a considerable time and the native seed may have been wasted. Weedy or aggressive species can prevent desirable natives from becoming established when they are planted too thin. However, few weeds can compete once a dense and diverse native turf has been formed. See this chapter for details.

E2. PRAIRIE MAINTENANCE: Burn or mow in late summer or early fall. The advantage of this minimal level of restoration is cost and time savings. The biggest disadvantage is degraded systems will probably be maintained in that poor state without additional planting. See this chapter for details.

F. RESTORING NATIVE PRAIRIE IN AND OLD FIELD: Manage as in E1. Burn or mow every third year. See this chapter for details.

G. RESTORING PRAIRIE ON BARE GROUND: Plow then plant as in E1. Burn or mow every third year. See this chapter for details.

H. RESTORING PRAIRIE ON STABLE SOIL: Remove trees and woody vegetation. May leave native shrub cover at about 10% of area. Apply herbicide to stumps of removed trees and shrubs to prevent area from being dominated by brush in a few years. If necessary, control seedling or resprouting brush mechanically or with herbicide. Don't plow. Seed using interseeding management in E1 in fall or early spring. Carefully control any weeds that appear. See this chapter for details.

LONG-TERM MANAGEMENT. Like all restoration projects and agriculture in general, restored grasslands will require maintenance. Exotic and native invasive species will begin invading the prairie as soon as restoration is begun. Control of these invaders and species enrichment should be part of the restoration plan. This will be discussed further below in the implementation section.

FUNDING. A number of state and federal funding sources are available to assist landowners with habitat management restoration projects. Some of these have very limited funding while others are typically under subscribed. Some are competitive and some are not. See Appendix C for a listing of funding sources.

RESTORATION IMPLEMENTATION

Once you have characterized a site, selected and designed a restoration scheme, developed a species list, designed a long-term management plan, and obtained funding, it is time to implement the restoration project. (Remember, by the definition used in this handbook, restoration includes maintenance and enhancement of existing grasslands.)

SITE PREPARATION. If planting is part of the restoration plan, the site must be prepared for planting. As mentioned under project planning, there are two basic methods of site preparation and seeding: interseeding without cultivation, and weed-free seedbed preparation using cultivation. Which is appropriate for your site?

Interseeding without cultivation relies on burning or mowing, with some spot herbicide use, to reduce competition from undesirable plant species. It is preferred where desired prairie species already exist, the area is too wet to cultivate, erosion might be a problem, and in savanna, where

cultivation would damage the roots of oaks and other existing desirable trees and shrubs. Fire is the preferred method of treatment because mowing is not as effective in reducing competition from woody species.¹⁰⁴ The cultivation method relies on traditional agricultural practices used to prepare a seedbed, such as plowing and cultipacker. It is the quickest way to restore vegetation to "old fields." The questions then are: to burn or not to burn? And, to plow or not to plow?

The first is easy to answer when burning is possible. Since grasslands are fire-dependant, you should burn. Unfortunately, in the Willamette Valley today, this is often not possible and alternative methods must be used. Late summer-fall mowing every two to three years is a possibility, however, the cuttings should be removed if at all possible. Cuttings left after mowing provide an excellent environment and mulch for invasive exotics such as non-native blackberries, tansy, and scotch broom. These will have to be controlled by periodic spot application of herbicides.

Haying a grassland, or one-third of it every third year, is an effective way of maintaining it. However, it should not be hayed until after July 15 at the very earliest to allow ground nesting birds to complete their nesting cycle and let the young fledge. The biggest disadvantage of this approach is the quality of the hay, which along with nutritional value, is low. There is, however, an increasing demand for native straw for erosion control and mulching. If your grassland is pure enough (no or few problem exotics), there may be a market for your late-season, poor quality hay. Contact suppliers such as those listed in Appendix F to see if they are purchasing native grass or straw and what their quality requirements are. If this market continues to develop, it may be a method of paying for restoring native grasslands.

The quickest way of restoring grassland vegetation is to plow and plant. It may not, however, be the quickest way to restore a grassland with diverse structure and a rare species component. Following is a series of restoration conditions and plowing recommendations.¹⁰⁵

- Do not plow if the site already has many native grassland plants, especially if some are rare species or difficult to restore spring-blooming species. Plowing will do more harm than good.
- Do not plow if the site already has a diverse, open turf. This type of site is a candidate for interseeding or no-till drilling.
- Do not plow among trees in a savanna. This will damage roots and possibly kill desirable trees and shrubs.
- Do not plow steep slopes.
- Do plow or disk or use herbicide on agricultural fields or abandoned/fallow fields (old fields) thick with undesirable species.
- Do plow or use herbicide on dense concentrations of perennial weeds.

Plowed or Tilled Seedbed Preparation. There are several methods of preparing the seedbed, depending upon existing vegetation.^{19, 107, 108} The easiest site to prepare is an active agricultural field. It will not be weed-free, but much of the preparation will already have been done. If perennial weeds are present, they should be eliminated by spot spraying with a short-life herbicide like Roundup® before tilling. Starting in the spring as soon as the ground can be worked, use a light-duty cultivator or harrow to till the ground no more than 2 inches deep. Deep tillage is not advisable as it only brings additional weed seed to the surface. Repeated harrowing or shallow cultivating will exhaust the surface weed-seed bank. The frequency of tillage will depend upon the annual weed population in the field. It should be done as often as a good crop of weed seedlings emerges, before the weeds get taller than 2 inches. Typically, the tillage interval is 3-5 weeks. This should continue until the onset of fall precipitation, September or early October, when the desired natives species are planted.

The most difficult site to prepare in plowed-ground grassland restoration is an old or abandoned. These fields are usually full of perennial, non-native weeds such as quack grass, Canada thistle, blackberries, tansy, and non-native grass sod. Control of these species requires persistence and may take several years.

To prepare old fields, first burn in the late fall or early spring if controlled burning is a possibility. If not, the field should be mowed closely with a rotary, sickle, or flail mower, and the litter should be removed if possible. Allow the vegetation to regrow to about 8 inches in height. Follow with a series of herbicide applications using a mixture of 2% glyphosate (Roundup®). If broad-leaved weeds are a problem, a 2% mix of 2,4-D and dicamba can also be used. Start herbicide applications in the late summer or early fall when perennial weeds are much more susceptible to herbicides. Make additional applications at 3-4 week intervals during the following growing season until all surviving weeds and seedlings are killed. Very tough weeds such as Canada thistle may require additional spot spraying to control.

Once the chemical control has been completed, the remaining above-ground vegetation can be removed by mowing. After that, the site should be cultivated in the fall, first with a deep tiller down to 6 inches. Cultivate a second time at right angles to the first. This will expose and kill any

remaining roots. In the spring, till with a double-disk or field cultivator to break the soil into small chunks. Again cultivate twice, at right angles to each other. The ground may then require harrowing with a diamond or spring-toothed harrow to smooth surface irregularities and ruts. Let the site set, ideally for a month, in the spring to encourage any remaining weeds to grow. If perennial weeds are still a problem, another herbicide application will be necessary. Severe perennial weed infestations may take up to two years to control.

In lieu of herbicides, a site can be prepared with intensive tillage, although this is not nearly as effective in controlling aggressive perennial weeds. If most of the vegetation consists of deep-rooted plants, such as tall fescue, and perennial weeds, the field will first need to be plowed, followed by disking to smooth the soil surface. This can be done in either early spring or fall. The field is then repeatedly disked at 3-5 week intervals through at least one growing season. Each disking consists of two passes over the field, at right angles to each other. The second spring, again disk and allow green-up to encourage any remaining weeds to grow. Then double-disk at right angles and harrow with a diamond or spring-toothed harrow to smooth surface irregularities and ruts. If perennial weeds are still a problem, a second summer of disking will be necessary.

Once weeds are under control, prepare the site for planting by packing the soil to eliminate air pockets that can dry out and kill newly emerging seedlings. Packing also creates a surface crust that prevents sub-surface moisture from drying out. Packing can be done with either a water-filled roller or a standard agricultural cultipacker. A field can not be over-packed and should be packed at least twice, at right angles to each other, before planting. A good rule of thumb on adequate packing is that a field is ready for seeding when your footprint is barely visible. More than half-inch deep prints mean more packing is needed. **When broadcast seeding, packing must be done after seeding.**

No-Till Seedbed Preparation. Two methods are commonly used to plant without preparing the seedbed by tilling: interseeding and no-till seeding. Interseeding broadcasts seed over existing vegetation without cultivation. No-till seeding uses a drill that opens a furrow in the ground, drops seed at a given rate and depth, and rolls the furrow closed.

Site preparation for interseeding is usually quite simple. Areas of relatively open turf such as Eurasian grass-dominated pasture need no preparation. If the existing vegetation is dense enough to deeply shade the ground during any part of the growing season, the site should be burned or mowed before planting. Several years of burning may break down a dense Eurasian grass turf. Even one burn followed by several years of mowing is effective. If burning is not possible,

mowing and removal of the thatch will work. Mowing alone is acceptable but the thatch provides ideal conditions for establishment of weedy species.

Interseeding can be used in weedy but diverse old fields and even in pure stands of aggressive non-native grasses, such as quack grass and orchard grass. In this case the existing vegetation will need to be mowed before interseeding. Mowing for 1-3 years after planting will reduce competition from weeds and help slow-growing seedlings become established.¹¹³ Interseeding of additional native species can also be used to increase the species diversity and improve the quality of predominantly native grasslands that are dominated by a few aggressive native species.

To prepare a site for no-till drilling, some vegetation management is often necessary. If the planting is going into an agricultural field, make sure that the soil is free from herbicide carry-over that may be harmful to germinating prairie plants, particularly the wildflowers. If a carry-over is suspected, it may a good idea to plant a cover crop such as meadow barley to prevent erosion and let the site rest for a year. If the field has standing corn or wheat stubble, shred the stubble so that it won't interfere with the colters or planting devices of the drill. Severe weed problems on old fields should be treated by allowing the vegetation to grow to a height of about 6 inches and then spraying with a non-selective herbicide such as Roundup®. A 2% solution will be sufficient to kill most weeds. A 2% solution of 2,4-D and dicamba can also be used for very aggressive problem-weeds such as thistle.

PLANTING. Grassland vegetation can be enhanced or established by seeding, transplanting, or a combination of the two. Seeding, which is the method most commonly recommended and used, is typically done in one of three ways: drilling, no-till drilling, and broadcasting. Transplanting is a method most commonly used to establish plants with tubers or rhizomes. It is also occasionally used to plant plugs of native plants, although this method is time-intensive and not very useful for large areas. It is probably most useful when planting rare species.

Seeding. The three typical methods of seeding — drilling, no-till drilling, and broadcasting — each have advantages and disadvantages. Drilling is an agricultural technique that allows efficient planting of large areas and results in the highest grass and forb establishment rate of any of the methods.¹⁰⁷ The biggest disadvantages of this method of seeding are the expense of the implement, if purchased, and need for clean seed to operate properly. In addition, planting of seed and consequent establishment of plants in parallel rows may not be aesthetically desirable. The cost of purchasing equipment may not be an issue, as more rental

equipment is becoming available all the time as restoration becomes more popular. The parallel rows generally become less apparent or disappear after the first few years as plants mature and fill in between the rows.

As previously mentioned, no-till drilling has the advantage of minimal soil disturbance, which limits potential for erosion and allows planting on vegetated areas with minimal disturbance to desirable species. The disadvantages of this method are similar to those for drills: expense of equipment, need for clean seed, and linear planting. However, as with drills, more rental equipment is becoming available all the time, and the aesthetic problems are generally temporary.

Broadcast seeding is the least expensive method, usually done either by hand from a bag, or with a mechanical broadcaster. Mechanical broadcasters range from a simple design that straps across the chest and throws seed out in a regular pattern as you walk and crank a handle, to a tractor-mounted or pulled fertilizer spreader that meters seed through a slot in the bottom and broadcasts it either by dropping it to the ground or throwing it in a regular pattern. The advantages of broadcasters are their economical price, except for some of the tractor pulled broadcasters; availability at nearly any hardware or farm store; and ability to handle seed with chaff and other material mixed in.

The biggest disadvantages of broadcast seeding include poor efficiency — broadcasting can require up to twice as much seed per area as drilling — poor control of seed placement and rates, and inability to handle fluffy seed without modifications to the machine. Broadcasting cannot be used on windy days because seed placed on the surface tends to blow away. One other disadvantage, except with interseeding, is the need for some type of mechanism to cover the seed and pack it into the soil. An inexpensive method of covering the seed is to drag a 2x4 board with heavy chains attached to it behind the broadcast seeding. The site also needs to be packed after seeding, either with a cultipacker or water filled roller.

Seed Drills are tractor-pulled farm implements that have a series of small plows or disks that open furrows in the soil, drop in a specified amount of seed from top-mounted storage boxes, and firmly pack the soil that falls back into the furrow after the seed is dropped. There are a number of native-seed drills available including those manufactured by Truax Company of Minneapolis, Minn.; Tye; Nesbitl Great Plains; and John Deere (power seeder and rangeland drill).¹⁰⁷

Seeding with a drill should be done immediately after the last cultivation and roller packing. A good natural rain does wonders for restoration seeding, so try to anticipate the weather and seed before a rain. In the Willamette Valley, fall

plantings in late September or early October are most likely to receive beneficial rains. Planting a cover crop of barley, wheat, "re-green" (sterile wheat hybrid or annual ryegrass) at 10-20 lbs./acre along with the native seed will help control erosion and weeds; it also provides nesting cover for birds for the first growing season.¹⁹

Start with a full seedbox and keep it that way as much as possible. Native-seed drills seed most efficiently when the box is more than one-quarter full. Make rounds around the entire area, overlapping some on the corners to prevent gaps when turning. Speed should be 2-3 miles per hour. Planting depth should be as recommended by the supplier or as listed in Appendix B. If not known, a good rule of thumb is a half-inch in clay, silt, or loam soils and three-quarters inch in sandy soils.¹⁰⁷ Cover the site completely once, then drill over it again at a right angle to the first pass. This will reduce the "row" appearance. Keep an eye on the seed-tube windows to ensure tubes do not become plugged. If a tube does become plugged, stop and clean it immediately.

No-till drill planting requires that the site be free of large or high-standing vegetation that will clog the planters on the drill or reduce contact of the planters with the soil, leaving seed on the surface where it will not germinate. See No-Till Seedbed Preparation, page 59, for proper site preparation to avoid this. Follow supplier recommendations or Appendix B for seed planting depths. Planting can follow contours or whatever feature desired. Plant in late September or early October to take advantage of fall and winter rains.

Broadcast and interseeding should be done shortly after the final cultivation, mowing, or other site preparation, if any. If a mechanical broadcast seeder is used, follow the instructions with the seeder. If mixing instructions are not provided, use the following hand mix instructions. Seed can be broadcast directly by hand, although a better method is to mix it with an inert carrier. To do this, mix seed well (if multiple species are being planted) and divide into two equal parts. Mix each part with an equal volume of horticultural vermiculite, clean sand, or other inert carrier such as sawdust. The carrier bulks up the seed, and makes it easier to spread and see where it has been broadcast. Some mechanical broadcasters also require mixing seed with a carrier, particularly small seed or seed with stiff hairs or barbs that tend to plug the spreader.

Spread the first lot of seed over a site in one direction, making regular transects. Spread the second lot at a right angle to the first, ensuring that no areas have been missed. The approximate target seeding rate is one cup of seed mix to 100 square feet, or one KGB (Kitchen Garbage Bag) to 18,000 square feet. To get a feel for spreading the mix at

these rates, measure off a 10x10 foot area and broadcast 1 cup of mix over it.

If planting on cultivated soil, rake or chain-drag the seed in and roller-pack with either a cultipacker or heavy roller. If the planting is an interseeding, no additional treatment is necessary after the seed is broadcast. For best results, planting should be timed to take advantage of rain. In the Willamette Valley, this is late September or early October.

Mosaic seeding is a method of planting that mimics the actual species continuum along moisture and slope gradients in a real prairie. It involves differential seeding rates and species mixes for different parts of the grassland. The southern face of hilly sites can be planted with drier adapted species and low wet areas planted with wet-meadow species. A secondary advantage to this approach is that it allows the restorationist to plant "showy" native grass and flower species where they are visible and can be enjoyed. The Commercially Available Willamette Valley Native Prairie Plant Species list provided on page 57 will help select species appropriate for wet and dry sites. Also visit the web pages of the suppliers listed in Appendix A or do a web search to find additional species that are "showy" or appropriate for site conditions. This can be fun, as it allows the restorationist to design the plant community.

Cover crops. The use of cover crops in grassland restoration is controversial. Some people, particularly those with agricultural experience, believe that planting of a perennial crop should be accompanied by sowing of a faster-growing annual crop to shade the soil, retain surface moisture and prevent sun-scalding of tender young perennial seedlings. Cover crops also outcompete annual weeds, reduce potential for soil erosion, and provide fuel for fire, if burning is planned. The contrasting opinion, held by many agrostologists, is that cover crops are not beneficial because they compete with the perennial plants for sunlight, moisture, and nutrients. They maintain that many agricultural fields have an abundant seed bank of annual weeds that act as a cover crop.

The decision to use a cover crop is left up to the restorationist. If a cover crop is used, choose an annual grass or grain like meadow barley, blue wildrye, or cereal grains. Some restoration specialists recommend not using wheat, as there is some evidence that it gives off underground chemicals that may interfere with germination of native seed.¹⁰⁷ The advantage of using fast-growing native grasses, such as meadow barley or blue wildrye, is that besides being native, they will persist in some areas as part of the restored grassland. The biggest disadvantage is cost; they are substantially more expensive than cereal grain seed. Mow the cover crop, at a level higher than the prairie

seedlings, before it goes to seed. Clippings should be removed by baling or other means, if possible, so that they will not form a mulch that is damaging to the native seedlings.

TRANSPLANTING. Transplanting is a common method of establishing prairie plants that have tubers or rhizomes, as well some bunch grasses that can be established by planting plugs. While many prairie plants can be established by this method, because it is time- and labor-intensive, it has limited utility for larger projects. The exception is establishment of rare plants, where the investment is worth the effort.

Tubers and Rhizomes. Species such as wild strawberry, American vetch, mules-ear, and beaked sedge have tubers or rhizomes that can be transplanted. Bunch grasses such as Columbia brome, California oatgrass, tufted hairgrass, and blue wildrye can be propagated by dividing and transplanting the bunches. These vegetative starts can either be purchased (Appendix A) or dug and replanted from neighboring donor sites. Remember, collecting from public lands requires a permit (see Appendix G). Transplanting is best done during the spring, fall, or winter when plants are dormant. When dug, each piece should contain 2-3 new buds or shoots at the base of the old stems or tubers or at the tips of rhizomes. They should be replanted just below the soil surface and the soil firmed down over each piece.

Starting and Transplanting Seedlings.¹⁰⁸ The seeds of many prairie plants can be planted, following stratification, in flats or peat pots for eventual transplanting to the restoration site. Propagators use flats filled with a 50/50 mixture of sand and commercial potting mix. See *Propagation of Pacific Northwest Native Plants*³⁴ for planting depths and additional planting instructions. Finely ground sphagnum is often dusted on the surface of the planted seedbed to reduce damping-off fungi. The seed bed is initially watered with a mist nozzle. Once the plants have attained enough growth, individual plants may be transplanted into small (2 1/2 inch diameter) peat pots.

Seedlings should be transplanted to peat pots in the fall so they are ready for transplant into the grassland restoration site in May or early June of the next year. The roots of the plants should be well developed and the shoot should have 4-5 leaves. When planting, make a hole in the soil large enough to accommodate the peat pot. Be sure to place the pot low enough in the hole so that soil can be firmed around the plant to prevent water loss from the potting mixture.

It is also possible to transplant mature 1 to 2 year-old plants that have been grown from seed in a nursery. These plants can be lifted from the soil with a shovel. If planting will be delayed, pack the roots or root ball in sphagnum to

prevent moisture loss. If mature plants are to be transplanted into a restoration site, follow these suggestions:

1. It is easier to plant in existing stands after prescribed burns or mowing have reduced vegetative cover.
2. Select the highest points in existing stands that are generally free of standing water throughout the year for plants that require dry habitat. Place other plants according to their moisture requirements. Remember, standing water will cause the roots of most upland grassland plants to rot.
3. Select areas that are open and mostly free of the large grasses that will crowd out wildflowers. It is possible to create openings in existing vegetation by using Roundup® to kill out grasses or undesirable vegetation. Allow several days between spraying and transplanting.
4. Plant deep enough to cover buds or crowns with 1 inch of soil. Exposed crowns will be killed by winter temperatures and summer heat.
5. Make sure the hole is completely closed around the plant and that there are no air pockets.
6. Because some grassland plants initiate growth in early spring, it is best to plant in the spring so the plants will be established before hot, dry summer conditions arrive.

COLLECTING SEED. Instructions for collecting wetland plant species are presented in the Seed collection section of the *Wetland* chapter. Good references for gathering and processing seeds are found in the chapters entitled "Obtaining and Processing Seeds"¹¹⁶ and "Tips for Gathering Individual Species"¹¹⁵ in *The Tallgrass Restoration Handbook*¹⁰¹ and the best times for collecting native seed are provided in *Propagation of Pacific Northwest Native Plants*.³⁴

CONTROLLING INVASIVE PLANTS¹⁷

Native grasslands are under continual threat of invasion by aggressive exotic and native plants. Exotic invasive species have become a problem for several reasons. First, a large number have become abundant and widespread in the Willamette Valley, often forming monocultures that crowd out natives. Second, the disturbed nature of much of the valley's landscape provides ideal growing conditions for many exotic invasives, favoring them over natives. Third, the small size and isolation of many of the native grasslands and their

high proportion of edge leaves them very susceptible to invasion by aggressive species.

The invasion or increase of aggressive exotic and native plants is usually the result of disturbance or degradation of a natural system by such things as livestock grazing, altered hydrology or fallowing of agricultural fields. The amount of control required depends on the nature of the invading species and the condition (degree of disturbance and restoration) of the restored grassland. In most cases, because of the three problems mentioned above, complete eradication is not possible; nearby seed sources will support continual reinvasion of the grassland.

Common control measures fall into two categories, chemical and mowing, although a third category, biological control, does exist. Both types of common controls can damage native species. The restorationist must consider the potential risks of control and alternatives, and use the least damaging approach given the resources available. Herbicides may be justifiable where mechanical control is not possible because of difficult land conditions or where infestations are large. Broad-scale application of herbicides on restored prairie is not desirable, however. Local applications or spot-spraying are usually used to reduce the population size of the aggressive species. Then a less damaging technique, such as fire, mowing, hand cutting or pulling, is used to control the problem. Combinations of techniques, such as mowing followed by spot spraying of new shoots and seedlings of aggressive species, generally work best.

REMINDER: *Grasslands should not be mowed until after mid-July in order to allow ground-nesting birds to complete their nesting cycle and to allow the young to fledge.*

A number of exotic invasive plant species are of particular concern in grasslands and prairies, including reed canary grass, Johnsongrass, quackgrass, medusahead rye, tansy ragwort, and exotic thistles such as Canada, bull, and Scotch thistles, and yellow starthistle. Additional aggressive exotic invasives are Himalayan and cutleaf blackberries, the brooms (Scotch, Spanish, and Portuguese), and yellow nutsedge. These species must be controlled for successful grassland restoration. The following information is provided to assist with their control or eradication.

Blackberries. See Control of Exotic Invasives section of Oak Woodlands and Savannas chapter, page 11.

Brooms. See Control of Exotic Invasives section of Oak Woodlands and Savannas chapter, page 11.

Reed Canarygrass. See Control of Unwanted Vegetation section of Wetlands chapter, page 28.

Johnsongrass.¹¹⁹ Johnsongrass is a tall perennial grass that spreads rapidly by seeds and rhizomes. It was thought to have been introduced into North America in the late 1700s as a forage crop. It grows to a height of 4-8 feet and has large open panicles type inflorescence (heads). The leaves can be recognized by a prominent white mid-rib and a membranous ligule (where the leaves join the stalk). The rhizomes are up to a half-inch in diameter and have tan to black scale-like leaves encircling the nodes (joints).

One of the characteristics of Johnsongrass that separates it from other perennial grasses and helps make it invasive is its prolific seed production and highly competitive seedlings. Johnsongrass can produce up to 10 bushels of seed/acre with a 90% or better germination and survival rate. Seeds can survive buried in the soil for over a decade. Over 90% of the rhizome growth occurs after flowering, when temperatures are warm. A single plant can produce more than 200 feet of rhizomes in one growing season.

Historically, Johnsongrass was controlled by tillage. Stands can be eliminated in one season by plowing in late spring when the grass reaches 18-24 inches high, and then retilling with a disk or sweep-type field cultivator every 3-4 weeks. This keeps growth under 12 inches and breaks up the rhizomes. Cultivation should continue until winter.

Mowing, when properly executed, can prevent seed formation and significantly reduce the vigor of established stands. The major disadvantage with this treatment is that mowing must start in May when ground nesting birds are in the peak of their nesting cycle. Mowing must continue at 3-4 week intervals until late fall.

Herbicides are probably the most effective form of control. If established stands are not too extensive, spot spraying with Glyphosate can be effective. Spray after plants are 18 inches tall and before seed emergence. Repeat treatment as necessary and plant perennial native grasses once Johnsongrass is eradicated. If stands are extensive, it is probably best to undertake an aggressive eradication program before attempting to restore grasslands. Consult *Pacific Northwest Weed Control Handbook*⁶² for appropriate herbicides and application rates for both spot application and boadscale application.

Quackgrass.¹¹⁹ Quackgrass is a rhizomatous perennial grass that is widely distributed in cool, moist climates. It grows to 1-3 feet in height and has seed heads similar to wheat. Leaves are about one-quarter-inch wide and somewhat hairy on the upper surface; they have clasping auricles or clasp the stalk where attached. The plant spreads by both rhizomes and seed. Flowering generally begins in mid-June and continues into summer. The main form of reproduction

is vegetatively through the rhizomes. Seeds do not seem to contribute much to the long-term survival of a plant. As many as 50 rhizomes can be produced per plant in a growing season. The plant continues to spread throughout a growing season as the spreading rhizomes' tips turn up to produce shoots that in turn form more rhizomes. Rhizome growth can be so prolific that a dense mat of these structures can usually be found just beneath the soil surface. The rhizomes are considered to have an allelopathic effect on other plants, retarding their establishment and growth.

Tillage can contribute significantly to quackgrass control. Before development of modern herbicides, extensive tillage was the major method of control. Two seasons of cultivation are needed to insure good control. Start plowing in late spring when the grass reaches 12 inches high and before seed development. Re-till with a disk or sweep-type field cultivator every 3-4 weeks, keeping growth under 12 inches and breaking up the rhizomes. Cultivation should continue until winter and commence again the second year once grass has begun to grow.

Mowing at 14-day intervals may help control quackgrass by depleting rhizome carbohydrates. The grass, however, survives quite well in areas mowed only 3-5 times during a season. It frequently is found as a weed in mowed lawns.

Herbicides are the best method of control of quackgrass. Several post-emergence herbicides have been developed that can provide excellent control of extensive established stands. Glyphosate can be applied before plowing and seedbed preparation, either in the spring or fall during active growth. Tillage subsequent to herbicide application can help eliminate escaped plants. Glyphosate can also be applied for burn-down at planting for no-till drilling. Spot spraying of small infestations with Glyphosate is also effective. Consult *Pacific Northwest Weed Control Handbook*⁶² for appropriate herbicides and application rates for both spot application and broad-scale application.

Yellow Nutsedge.¹¹⁹ Yellow nutsedge is a perennial and member of the sedge family. It reproduces primarily by rhizomes and tubers and grows to 1-2 ½ feet tall. Tubers are produced at the end of each rhizome by fragile connections that can be easily broken. Under good conditions, a single plant can produce several thousand tubers in a season. When tubers sprout they produce a vertical rhizome that terminates in a slender shoot. As the rhizome and shoot grow upward through the soil, the shoot forms a small, solid bulblike structure called a basal bulb. This structure is very active, producing roots and additional rhizomes. The rhizomes grow laterally and produce more shoots that repeat the process, spreading the plant in all directions. Under good conditions, a single plant can produce several thousand tubers in a

season. Yellow nutsedge tubers can survive freezing in undisturbed soil. Flowering is erratic and may not occur at all during a growing season. Tubers can survive in the soil for a number of years.

Tillage, unless done repeatedly and intensively, does little to control yellow nutsedge. In fact, it can contribute to the spread of this noxious weed by breaking up rhizomes and scattering tubers. Typically, two or more seasons of intense tillage are necessary to control the species. Mowing is also ineffective as the plants are low-growing and survive mowing.

Control of nutsedge requires multiple control practices spread over the entire growing season. A typical program consists primarily of early-season suppression by tillage and herbicides, followed by late-season tillage and herbicides. Complete control over one season is impossible because of the species' ability to produce dormant tubers. Several years of treatment are necessary. Selective application of glyphosate will help suppress nutsedge, although repeated application will be necessary as tubers in the soil sprout and produce new plants. Severe infestations of this weed should be treated for several years before prairie restoration is attempted. Consult *Pacific Northwest Weed Control Handbook*⁶² for appropriate herbicides and application rates for both spot application and broadscale application.

Tansy Ragwort.¹²⁰ Tansy is a member of the sunflower family that is poisonous to livestock. It is a biennial or short-lived perennial introduced from Europe and Asia Minor in about 1913. It has two growth forms, a low-growing rosette the first year and flowering plant the second. The rosette has leaves 2-10 inches long, irregularly lobed with the terminal lobe being larger than the lateral lobes. The leaves are generally 10-20 in number attached directly to the main stalk. When crushed, the leaves give off a rank odor, hence the colloquial name "stinking willy." The flowering plant typically grows to 1-3 feet in height and has compound varied leaves, i.e. they are mostly deeply lobed, becoming smaller closer to the flowers. Stems and flower stalks are usually purplish. The daisy-like flowering heads are about one-half inch across, yellow, with 10-16 ray flowers. Many flowering heads can be produced on one to 15 clusters, depending on the size of the plant. Flowering typically occurs from July to October.

Seeding occurs after flowering in the fall, with large, multiple-stalked plants producing over 150,000 seeds. Two types of seeds are produced, lighter ones that tend to be dispersed by the wind and heavier ones that tend to fall directly off the plants. Most seeds fall within 10 feet of a plant. The size of the seed bank is positively correlated with the historical abundance of plants. Viable seeds persist

longer at increasing depths below the soil surface and may survive for over 15 years. Pristine plant communities are generally resistant to ragwort infestations, but local disturbances such as rodent burrows, a common characteristic of native grasslands, can give it the start it needs.

The management of tansy infestations is especially important and most landowners want it eradicated. However, the reality is that tansy persists in an area once infestations are established. The most practical way of dealing with chronic infestations is through integrated vegetation management. In new, isolated infestations, prompt eradication of plants is imperative. Rosettes should be treated with an appropriate herbicide, and bolting (transitioning from rosette to flowering plant) and flowering plants should be pulled.

Mechanical control has limited application. Plants damaged in the spring by mowing typically produce multiple flowering stalks or smaller lateral shoots that will bloom later in the year. Mowing in late summer may reduce seed production, but the plants may survive through the winter to produce more robust plants the next year. If mowed in late summer, patches should be treated with a herbicide after resprouting occurs.

As previously mentioned, hand removal of flowering plants before seed production may be effective in lightly infested areas. Plants that are pulled while flowering should be bagged and burned to destroy the seeds. Removal should occur before seed development to prevent seed dispersal by handling and development of micro-seedbeds where soils are disturbed by pulling plants.

Chemical control is effective in controlling tansy ragwort. *The Pacific Northwest Weed Control Handbook*⁶² recommends the use of Weedmaster® (2,4-D+Dicamba) and Crossbow® on actively growing tansy. Weedmaster® should be applied at the rate of 2.0 quarts/acre and Crossbow® at the rate of 1.502 quarts/acre. Older infestations generally require several years of treatment.

Several biological controls are also available, however, this approach will only reduce the infestation, not eliminate it. Insects used to control tansy include the cinnabar moth (*Tyria jacobaeae*), ragwort flea beetle (*Longitarsus jacob-aeae*) and ragwort seed-head fly (*Botanophila seneciella*).

Medusahead Rye.¹²¹ Medusahead, an annual grass native to Eurasia, was first found in North America in 1884 in the Umpqua Valley of southwestern Oregon. By 1915 it had become common in the Willamette Valley. It is considered a noxious weed because it can dominate a

grassland, resulting in very low plant species diversity, low forage value, and little value for wildlife habitat and watershed function.

During the seedling stage in late fall or early spring, medusahead can be recognized by its slender and delicate-looking bright green leaves. When a seedhead starts to develop in the late spring, it is wrapped in leaves and has visible awn tips. As it matures, the seed head becomes totally visible and the awns stick straight up from the seed. It is not until the plant starts to dry out that the awns start to take on the twisted appearance by which the plant is typically identified. Plants are capable of producing tillers (like runners) and can grow to 8-20 inches in height. The grass contains two or three spikelets at each node of a spike. Each spikelet contains one seed with the typical number of seeds per spike being 8-15.

Medusahead most typically invades areas that have been degraded by overgrazing, fires, or cultivation, but it is capable of establishing and maintaining itself in diverse communities of native perennials. Once established, it can rapidly dominate a site. Seeds germinate in the fall, winter, or spring, and root growth continues through the winter. The species is deep-rooted with roots being found as deep as 40 inches below the surface. Plant maturity occurs in late June-early July, and seeds tend to remain on the heads until late summer-fall. Seeds up to three years old still have better than a 90% germination rate.

Fall burning can effectively reduce redusahead, as can Spring plowing. The latter, after medusahead has germinated, has resulted in up to 95% reduction in the grass. Disking has been reported to provide up to 50% reduction. A combination of herbicides and plowing or disking provides the best control results. Glyphosate applied at 0.375 lbs/acre in early spring, while the plants are still small, is an effective control. This application rate is low enough not to damage desired native competitors. Consult *Pacific Northwest Weed Control Handbook*⁶² for additional information on appropriate herbicides and application rates.

Biennial Thistles.¹²² These thistles live for two years, germinating and growing into rosettes the first year, overwintering as rosettes, and bolting into flowering plants the second year. Common non-native biennial thistles include bull thistle, musk thistle, and Scotch thistle. Bull thistle has a short, fleshy tap root and grows to 2-5 feet tall with many spreading branches. Leaves are more or less lance-shaped, lobed, 3-6 inches long, and have prickly hairs on the top side and are woolly underneath. Leaves are tipped with stout, needle-like spines. They have bright purple, fragrant flowers that are 1½ to 2 inches in diameter, 1-2 inches long, solitary at the ends of branches. Bull thistle is not native to North

America and is thought to have entered the United States via overseas shipping through Portland in the late nineteenth century.

Bull thistle proliferates and thrives in pastures that are heavily grazed and fertilized but can do well in ungrazed native grasslands as well. Seed production is enhanced by disturbance, with up to three times as many seeds being produced by plants in highly disturbed areas.

The musk thistle group, which was introduced from Europe in the 1800s, is comprised of three different species that are very similar and have the same management requirements. Young rosettes are not deeply lobed, but each lobe has 3-5 points tipped with spines. As they become older, lobes become deeply cut, with each tipped with white or yellow spines. Rosettes can be over 2 feet in diameter. The plant develops a large, fleshy, corky taproot that is hollow near the soil surface. In its second year, musk thistle bolts and shoots grow from 2-6 feet tall. Leaves are dark green with light-green midribs and white margins. Flowering shoots are very branched and support solitary purple flowers that are 1½ - 3 inches in diameter and may bend or nod. Seed production is quite variable, depending upon habitat conditions. An average plant produces 10,000-11,000 seeds, of which about 33% are viable. These seeds may remain viable in the soil for a decade or more. Like bull thistle, musk thistle seed germination is favored on poorly vegetated sites that have been disturbed.

Scotch thistle, a native to Europe and Asia, was introduced into North America in the late nineteenth century. Its leaves are large, green, spiny, and covered with fine dense hairs on both sides, giving them a grayish-green, cottony appearance. First year rosettes are 10-12 inches in diameter. Their leaves are oblong and may be up to 2 feet long with distinct white mid-ribs. Second-year flowering shoots may grow up to 8 feet tall, are very hairy, and have a distinct winged appearance. Leaves have prominent triangular lobes that end with a prominent sharp, green to white spine. Flowerheads, which support pale-purple to red flat-topped flowers, are numerous and on the ends of primary and secondary shoots. This thistle seems to prefer wetter sites such as swales, gullies, and wetlands. It is not a major seed producer, with 70-310 flower heads per plant producing 110-140 seeds per head.

Mechanical control can be effective on thistles. Because biennial thistles don't reproduce from their roots, any mechanism that severs the root below the soil surface will kill them. Tillage, hoeing, or even hand-pulling will work as long as it is done before seed production. Mowing will also work. Mowing of musk thistle two days after flowerheads open to full bloom will eliminate seed production. However, a single

mowing is usually not effective in controlling an infestation because growth stage variability in a population will insure that some of the plants will survive and produce seed. It is also essential that sites where thistles were growing be revegetated because they will inevitably be re-invaded from seeds in the soil.

Biennial thistles can also be controlled with herbicides, although some growth stages are more difficult to kill than others. For instance, spraying bolting to bud-growth stages with some of the herbicides that were effective on rosettes did not eliminate viable seed production. Thistles can be difficult to kill, requiring some of the stronger herbicides. Box 10 contains a list of recommended herbicides, application rates, and best times to apply.

Canada Thistle.¹²³ Canada thistle was probably originally native to southeastern Europe, although today it is so wide spread that its origin is difficult to determine. It was likely introduced to North America with European settlement, sometime in the 1600s. It has a wide habitat range and is an aggressive perennial weed that infests arable and nonarable lands. It spreads by both seed and creeping horizontal roots that can reach 16 feet in length and penetrate the soil up to 22 feet deep. Canada thistle leaves are spiny and deeply lobed on several branching flower stalks. They can be up to 8 inches long, with crinkled edges and spiny-toothed margins, and ending in a spine. The half-inch diameter, pink flowering heads form clusters on the ends of branches. This thistle can form dense infestations, with one individual seedling capable of rapidly forming a large patch through vegetative reproduction of the root system. Above-ground foliage generally dies back in the winter, resprouting from the roots the next spring. Seed has been known to still be viable after over 22 years in the soil.

Canada thistle can be controlled by repeated cultivation as long as a regimen of 21-day repetition over 122 days is followed. If not, the disturbance will break up and spread the root system, greatly increasing the infestation. Six cultivation's with duckfoot-sweeps at 21-day intervals will decrease shoots by 98% after one season. Mowing has had mixed results. In one investigation, two mowings a summer, the first being before seed development, reduced a thistle population by 86% in one year and 100% after four years. In a second study, mowing 3-4 times per year eliminated Canada thistle in three years. However, a third study found that mowing only kept Canada thistle infestations in check but did not eliminate them.

Seedlings are easily killed by tillage, or hoeing before they become perennial in nature and begin growing the

extensive root system. Because seedlings are not competitive when shaded, revegetation of disturbed areas is important to keep seed in the soil from germinating.

Canada thistle is very difficult to control with herbicides. Reviews of chemical control research show that single herbicide applications did not provide long-term control due to the difficulty in killing the root system. Effective control requires multiple applications. Several herbicides are registered for control of Canada thistle on rangeland. Besides proper applications rates, timing is critical for maximum control. 2,4-D is probably the most effective herbicide for the weed. For best results, this chemical should be applied at a rate of 1.5 to 2.0 lb. acid equivalent/acre before plants reach the bud stage. Consult *Pacific Northwest Weed Control Handbook*⁶² for additional information on appropriate herbicides and application rates.

BOX 10 HERBICIDES AND RATES TO CONTROL BULL, MUSK, AND SCOTCH THISTLES IN PASTURES, RANGELAND, AND NON-CROP AREAS.		
Herbicide	Mixture rate (lb. active ingredient / acre)	Timing/Remarks
Clopyralid	0.13 to 0.5	Rosettes in spring or fall
Clopyralid + 2,4-D	0.2+1.0 to 0.3 + 1.5	Rosettes in spring or fall
Dicamba	0.5 to 1.0	Rosettes in spring or fall
2,4-D	1.5 to 2.0	Rosettes in spring
2,4-D + dicamba	1.0 + 0.5	Rosettes in spring
Picloram	0.13 to 0.25	Rosettes in spring or fall
Chlorsulfuron	0.047 (0.75 oz. active ingredient)	Spring from bolting to bud stage, add a non-ionic surfactant
Metsulfuron	0,019 (0.3 oz active ingredient)	Spring from bolting to bud stage, add a non-ionic surfactant

*Herbicides should only be spot-sprayed when applied to thistle growing with native species.

Meadow knapweed¹²⁴ is a fully fertile hybrid black knapweed (*C. nigra*) and brown knapweed (*C. jacea*), both European natives. It was first documented in Oregon in Multnomah and Lane Counties between 1910 and 1920, and was cultivated for winter forage in Douglas County prior to 1959.

Meadow knapweed is a "weed on the move" both geographically and genetically. Populations have expanded rapidly west of the Cascades and new infestations have recently appeared in wetter areas of eastern Oregon and Washington. The species is reported to be hybridizing with yellow starthistle and diffuse knapweed in Oregon.

Meadow knapweed is a perennial that grows from a woody crown. Upright stems, 20 to 40 inches tall, branch from near the middle. Leaves are not finely divided, like many other knapweeds, and may grow up to 6 inches long by 1 ¼ inches wide. Margins may be either entire or have small lobes or teeth. Flowers are rose-purple (occasionally white) and borne in heads about the size of a nickel. Flower heads are nearly round rather than the urn shape common on starthistle and other knapweeds. Flowering usually peaks in July-August but can continue through November-December in warmer climates.

Meadow knapweed invades moist sites such as irrigated pasture, moist meadows, riverbanks, streams, rivers, and irrigation water, in hay or by vehicles.

Mechanical control of meadow knapweed includes digging out initial infestations, if only a few plants, or cultivation, if infestations are more extensive. Resprouting is likely after the first cultivation so repeated efforts are necessary. Also, consider the seed reserve in the soil and plan to either deplete it using herbicides or repeated cultivation, or prevent germination by deep burial or surface shading. The latter can be accomplished by planting a cover crop of grasses, although some spot application of herbicides will likely still be necessary to eradicate the weed. See the *Pacific Northwest Weed Control Handbook*⁶² for information on appropriate herbicides and application rates.

Mowing has not proven very effective in removing meadow knapweed. Three seed-feeding insects — a moth (*Metzneria paucipunctella*) a weevil (*Larinus munutus*), and a fly (*Urophora quadrifasciata*) — have been established on meadow knapweed but, to date, have not controlled it. The weevil is the most promising agent if its numbers increase, as they do on spotted and diffuse knapweed.

Invasive Native Species. A number of aggressive native species can be invasive in grasslands in the absence of natural processes such as fire. Some of the most problematic are

woody plants such as poison oak, Oregon ash, hawthorn, and some of the wild roses, all of which are natural components of Willamette Valley prairie. The question then becomes, should you control native shrubs and trees or not? The answer depends on whether the woody species were an integral part of the original community being restored, and whether they occur at the densities approximating natural conditions. In the majority of cases, these species are an integral part of the community, but their density is too high. Poison oak is a good example. It historically occurred in dry upland prairie but apparently was not dominant. Today, in the absence of fire and in incomplete native plant communities, it can rapidly overwhelm an area. In most cases, it should probably be controlled.

A second consideration before deciding to control aggressive native species is their importance to native wildlife on the site. Before reducing shrubs and trees, pay attention to which animals use these species and consider if their needs can be met elsewhere or in other ways. For example, do wintering birds seem to be depending heavily on Douglas hawthorn berries? If so, either leave a few trees (the best approach if hawthorn was a component of the original community) or provide food for them someplace else. Remember, leaving aggressive species that were part of the original grassland community will require future active management of the site. The remaining plants will be a source of continual invasion of the area. Native habitat restoration is not low on effort and commitment. The word "fallow" does not occur in the restorationist's vocabulary.

Mechanical methods such as mowing can be effective in controlling some woody native species, although it seldom eradicates them. Poison oak, for example, may continue to persist in a low growth-form below the mowing level. If mowing is used as a management tool, it should not be done until after mid-July to allow ground-nesting birds an opportunity to raise their young.

Stem cutting of shrubs and trees at or near the ground can be effective. Loppers or a hand saw can be used for small stems (under 2 inches in diameter) and small areas. A gas-powered brushcutter or chain saw is more efficient for larger stems and acreages. Many of the woody species will resprout from roots or their root collar if a herbicide is not applied after cutting (see herbicide discussion below). If herbicides are not used, resprouts can be cut until food reserves are depleted. This may require numerous cuttings and many years. Species such as hawthorn are almost impossible to kill without herbicide application to the cut stems.

Girdling is an effective method of killing larger shrubs and trees. Use an ax or saw to make two parallel cuts around the trunk about 3-6 inches apart. These cuts should be just a

bit deeper than the cambium layer, which is immediately below the bark. Then whack the bark between the two cuts sharply with the back of your ax. After a couple of strikes, the outer bark with cambium will tend to pop off, leaving a smooth area where it separated from the trunk.

Herbicides provide an efficient method of controlling invasive woody vegetation, either by direct foliar application or in conjunction with mechanical treatments.^{117, 119} Herbicides can be applied to leaves with a hand-held or power-driven sprayer, and to the bark or stump of woody species with a wick applicator, hand-held sprayer, or other type of hand-held applicator, such as a paint roller.

Foliar treatment with Krenite®, a non-volatile contact herbicide that inhibits bud expansion, between July and September is an effective method of killing shrubs and trees. Complete coverage is required, so over-spray and damage to adjacent desirable woody plants should be considered before this approach is used. Because of its selectivity, Krenite® is a preferred foliar spray. A non-ionic surfactant will improve its effectiveness. Krenite S® contains the appropriate amount of surfactant in the spray.

Foliar application of dicamba herbicides — such as Banvel® and 2,4-D herbicides under a variety of names including Crossbow® — is effective against all broadleaf plants, woody as well as herbaceous. Dicamba should not be used in grasslands or near woody plants that you want to save. There are also problems with drift with these herbicides, particularly in warm weather. They should only be used in situations where drift or mobility is not a problem, such as with complete removal of vegetation in an area prior to the start of restoration. They can be used during the dormant season to control aliens that remain green.

Frilling is a means of killing a standing tree with a herbicide. The tree trunk is gashed a number of times around the trunk at a 45° angle with an ax or chain saw, and a herbicide is applied to the gashes. Herbicides are applied at full strength or diluted somewhat with water, and applied at low volume.

Basal spraying involves saturating the lower portion of the woody stem with herbicide. The objective is to wet individual stems to run off from a height of approximately 18 inches to the groundline, including the root collar. Herbicides applied as basal treatments usually are mixed with a nonpetroleum-based herbicide oil or oil-water carrier to enhance penetration of the bark. Diesel fuel may be used instead of a nonpetroleum-based oil, however, it has a far greater potential for damaging nontarget plants. Garlon 4®, mixed 3 ounces to a gallon of oil, is effective on trees and sprouts up to 6 inches in diameter. Higher concentrations, as recom-

mended by the manufacturer, are effective against woody species that resprout vigorously. This treatment can be done any time of the year. A variation is thin-line basal-bark spraying with Garlon 4® at full concentration or mixed 50:50 with diesel fuel. The herbicide is applied in a pencil-point line around the trunk, 12 inches above the ground. This treatment should be done during the dormant season.

The best method of controlling most invasive woody natives is a combination of mechanical techniques and herbicide application. Mowing in late summer and then spot spraying with Garlon 3A® can control problem shrubs such as poison oak and roses. Girdling can be used with an application of a herbicide, such as solution of 50% glyphosate (Roundup®), applied to the cuts. Roundup® is also effective in preventing reprofiting from tree stumps when applied directly to the cut stump. A 10-20% solution (manufacturer recommends 50-100% solution) is applied either by spraying individual stumps with a backpack sprayer, or wiping each stump with a sponge applicator or paint roller. If a sponge or roller is used, be very careful with spills, as this herbicide is not selective and will kill anything with green leaves that it touches. Application must be immediately after cutting.

Garlon 3A® is a selective translocated herbicide that provides a high level of control of tree root systems when applied to cut stumps, especially those of suckering species such as hawthorn. An undiluted to 50% solution of Garlon 3A® should be sprayed or wiped on stumps. Cut-surface application can be made during any time of the year, but application during the late growing season (July-September) is most effective.

GRAZING. Proper grazing can be an effective management tool because it reduces the buildup of litter and stimulates grass growth. A preferred technique is a deferred rest-rotation system that leaves one pasture per year ungrazed, which concentrates the impacts of grazing, and limits animals' access during the period when ground-nesting birds are nesting. If the grassland is newly established, no grazing should be allowed until years 3-5, depending on how quickly perennials become established and a turf is developed. A grazing plan should be developed that is tailored to the site. The NRCS or soil and water conservation district can assist with this (see Appendix D).

MAINTENANCE. As previously noted, native habitat restoration is not low on effort and commitment. Continual maintenance will be necessary to maintain the open grassland landscape. In the absence of complete prairie systems that include fire, exotic and native invasive species, shrubs, and trees will continually invade and try to take over the grassland. Continual monitoring is necessary with the appropriate restoration actions initiated when needed.

Appendix A: _____

Common and Scientific Names of Plants, Habitats Where They Most Commonly Occur, and Some Sources for Native Plant Stock

(Names and Habitats follow: Cooke, S.S.⁷³, Franklin, J.F. et al.⁹⁶ Pojar, J. and A. MacKinnon,⁹⁷ Simpson, et al.⁹⁸ Guard, B.J.; Hitchcock, C.L., and A. Cronquist⁹⁹)

SPECIES	Habitat Type							NURSERY‡
	Wetland & Bottomland				Grassland		Oak Woodland & Savanna	
	Shallow Water	Marsh	Shrub Swamp	Bottomland Hardwood	Riparian	Wet Prairie		
Trees:								
Grand Fir <i>Abies grandis</i>				X				j, m, n, s, v, cc, dd, ii,
Vine Maple <i>Acer circinatum</i>				X	X			a, f, h, j, l, m, n, o, p, r, s, v, y, aa, cc, ee, ii
Bigleaf Maple <i>Acer macrophyllum</i>				X	X			a, b, d, f, h, j, l, m, n, o, r, t, y, aa, cc, dd, ff, ii,
White Alder <i>Alnus rhombifolia</i>					X			j, n, v, cc, aa, dd, ii,
Red Alder <i>Alnus rubra</i>				X	X			a, b, d, e, f, j, l, m, n, o, r, y, aa, cc, dd, ff, gg, ii,
Pacific Madrone <i>Arbutus menziesii</i>							X	e, m, o, p, cc, ff, ii,
Pacific Dogwood <i>Cornus nuttallii</i>				X				n, r, s, aa, ii,
European Hazel (filbert)* <i>Corylus avellana</i>				X	X			
Western Hazel <i>Corylus cornuta</i> var. <i>californica</i>				X			X	n, aa, ee, ii,
Black or Douglas Hawthorn <i>Crataegus douglasii</i> var. <i>suksdorfii</i>			X	X	X	X	X	a, e, f, j, m, n, o, s, v, y, aa, dd, ee, gg, ii,
English Hawthorn* <i>Crataegus monogyna</i>				X	X	X	X	
Oregon Ash <i>Fraxinus latifolia</i>			X	X	X	X		a, b, d, e, f, h, j, n, o, y, aa, cc, dd, ee, ff, ii,
English Holly* <i>Ilex aquifolium</i> .				X			X	

* Non-native species

‡ Not an exhaustive list of nurseries. Use Internet search engine to locate additional suppliers.

SPECIES	Habitat Type							NURSERY‡	
	Wetland & Bottomland				Grassland		Oak Woodland & Savanna		
	Shallow Water	Marsh	Shrub Swamp	Bottomland Hardwood	Riparian	Wet Prairie			Upland Prairie
Oregon Crabapple <i>Malus fusca</i>				X	X				d, m, n, aa, cc, ii,
Domestic apple* <i>Malus domestica</i> .				X	X	X			
Willamette Valley Ponderosa Pine <i>Pinus ponderosa</i>				X				X	b, j, n, q, r, s, x, dd, gg, ii,
Black Cottonwood <i>Populus trichocarpa</i>				X	X				d, e, j, m, n, y, v, aa, cc, ee, ff, gg, ii,
Bitter Cherry <i>Prunus emarginata</i>				X	X				m, n, o, cc, dd, ii,
Chokecherry <i>Prunus virginiana</i>				X	X			X	m, n, o, s, v, y, aa, cc, dd, gg, ii,
Domestic Cherry* <i>Prunus avium</i>				X	X			X	
Douglas-fir <i>Pseudotsuga menziesii</i>				X	X			X	b, j, m, q, s, x, y, cc, dd, ff, ii,
Domestic Pear* <i>Pyrus spp.</i>				X	X	X		X	
Oregon White Oak <i>Quercus garryana</i>				X			X	X	a, b, d, e, f, h, j, m, n, o, p, r, s, t, aa, cc, ee, ii,
California Black Oak <i>Quercus kelloggii</i>							X	X	ii,
Cascara <i>Rhamnus purshiana</i>				X	X			X	j, m, n, o, r, cc, ee, ii,
Geyer Willow <i>Salix geyeriana</i>	X				X				n, v,
Pacific Willow <i>Salix lasiandra</i>			X	X	X				m, j, r, v, cc, ee, gg, ii,
Piper Willow <i>Salix piperi</i> ,			X		X				a, d, f, j, l, m, y, cc, ii,
Scouler Willow <i>Salix scouleriana</i>			X	X	X				d, f, j, l, m, n, r, v, y, aa, cc, ee, ff, gg, ii,
Northwest Willow <i>Salix sessilifolia</i>			X		X				n, cc,
Sitka Willow <i>Salix sitchensis</i>			X	X	X				a, d, e, f, j, l, m, n, v, y, aa, cc, ee, gg, ii,
Western Redcedar <i>Thuja plicata</i>				X	X				m, n, o, s, v, ee,
Shrubs:									
Pacific Serviceberry <i>Amelanchier alnifolia</i>				X				X	a, e, f, j, m, n, r, s, v, y, aa, cc, dd, ee, gg, ii,
Manzanita <i>Arctostaphylos spp.</i>								X	o, y, cc, ii,

* Non-native species

‡ Not an exhaustive list of nurseries. Use Internet search engine to locate additional suppliers.

SPECIES	Habitat Type								NURSERY‡
	Wetland & Bottomland					Grassland		Oak Woodland & Savanna	
	Shallow Water	Marsh	Shrub Swamp	Bottomland Hardwood	Riparian	Wet Prairie	Upland Prairie		
Kinnikinnick <i>Arctosaphylos uva-ursi</i>								X	a, g, k, l, y, cc, dd, ee, gg, ii,
Tall Oregongrape <i>Berberis aquifolium</i>				X				X	f, l, m, n, o, p, r, s, v, y, aa, cc, dd, ee, gg, ii,
Butterfly Bush* <i>Buddleia davidii</i>				X	X			X	
Redstem Ceanothus <i>Ceanothus sanguineus</i>								X	n, v, y, cc, dd, ii,
Red-osier Dogwood <i>Cornus stolonifera</i>			X	X	X				a, c, f, g, h, j, k, l, m, o, p, r, v, y, cc, dd, ee, gg, ii,
Scotch Broom* <i>Cytisus scoparius</i>				X	X	X	X	X	
Ocean Spray <i>Holodiscus discolor</i>				X	X			X	a, d, e, f, j, l, m, n, o, r, v, y, aa, cc, dd, ee, gg, ii,
Black twinberry <i>Lonicera involucrata</i>				X	X				d, f, m, n, r, aa, cc, dd, ee,
Indian Plum/Osoberry <i>Oemleria cerasiformis</i>				X	X			X	a, d, e, f, m, n, o, r, y, cc, ee, ii,
Mock Orange <i>Philadelphus lewisii</i>				X	X			X	a, j, m, n, o, r, v, y, aa, cc, ee, gg, ii,
Pacific Ninebark <i>Physocarpus capitatus</i>				X	X			X	a, d, f, j, l, m, n, o, r, v, y, aa, cc, ee, gg, ii,
Pacific Poison Oak <i>Rhus diversiloba</i>				X			X	X	
Red Flowering Currant <i>Ribes sanguineum</i>				X	X				m, n, o, r, v, cc, dd, ee, gg, ii,
Sweetbrier Rose* <i>Rosa eglanteria</i>				X	X	X	X	X	
Nootka Rose <i>Rosa nutkana</i>			X	X	X	X	X	X	a, d, e, f, g, l, m, n, o, p, r, v, y, aa, cc, dd, ee, gg, ii,
Clustered Wild Rose <i>Rosa pisocarpa</i>					X	X			a, c, d, e, f, m, n, o, cc, ee, ii,
Himalayan Blackberry* <i>Rubus armeniacus</i>				X	X	X	X	X	
Evergreen or Cutleaf Blackberry* <i>Rubus laciniatus</i>				X	X	X	X	X	
Blackcap Raspberry <i>Rubus leucodermis</i>				X					n, o, cc, dd, ii,
Thimbleberry <i>Rubus parviflorus</i>				X					a, f, m, n, o, v, y, cc, dd, ee, ii,
Salmon Berry <i>Rubus spectabilis</i>				X	X				a, d, e, f, l, m, n, o, v, y, dd, ee, ii,
Trailing Blackberry <i>Rubus ursinus</i>				X	X			X	n, o, v, dd, ii,
Blue Elderberry <i>Sambucus cerulea</i>				X	X				d, e, j, n, o, r, v, y, aa, cc, gg, ii,

* Non-native species

‡ Not an exhaustive list of nurseries. Use Internet search engine to locate additional suppliers.

SPECIES	Habitat Type							NURSERY‡
	Wetland & Bottomland				Grassland		Oak Woodland & Savanna	
	Shallow Water	Marsh	Shrub Swamp	Bottomland Hardwood	Riparian	Wet Prairie		
Red Elderberry <i>Sambucus racemosa</i>				X	X			a, e, f, j, m, n, o, r, v, y, aa, cc, dd, ee, gg, ii,
Douglas Spiraea or Hardhack <i>Spiraea douglasii</i>			X	X	X	X		a, d, e, f, j, l, m, n, o, r, v, y, aa, cc, ee, gg, ii,
Common Snowberry <i>Symphoricarpos albus</i>				X	X		X	a, d, e, f, h, j, l, m, n, o, v, y, aa, cc, dd, ee, gg, ii,
Oval-leaf Viburnum <i>Viburnum ellipticum</i>				X	X		X	m, n, aa, ii,
Forbs:								
Common Yarrow <i>Achillea millefolium</i>							X	e, f, g, m, n, o, v, y, w, cc, dd,
Water Plantain <i>Alisma triviale</i>	X	X	X			X		d, o, w, cc, ee, ii,
Slimleaf Onion <i>Allium amplexans</i>							X	o,
Pearly Everlasting <i>Anaphalis margaritacea</i>					X		X	m, n, o, v, y, cc, dd, ii,
Red Columbine <i>Aquilegia formosa</i>					X		X	m, n, r, v, y, cc, ee, ii,
Goatsbeard <i>Aruncus dioicus</i>				X	X			f, m, n, ee, ii,
Wild Ginger <i>Asarum caudatum</i>				X				f, m, r, ee, ii,
Hall's Aster <i>Aster hallii</i>						X	X	
Douglas Aster <i>Aster subspicatus</i>					X	X	X	d, m, n, o, r, cc, ii,
Deltoid Balsamroot <i>Balsamorhiza deltoidea</i>							X	o, v, y, cc, dd,
Nodding Beggarticks <i>Bidens cernua</i>		X			X	X		
Hyacinth brodiaea <i>Brodiaea hyacinthina</i>						X	X	m,
Leichtlin's Camas <i>Camassia leichtlinii</i> ssp. <i>suksdorfii</i>				X		X	X	m, n, o, ii,
Common Camas <i>Camassia quamash</i> ssp. <i>maxima</i>						X		d, f, g, i, n, o, r, v, y, aa, cc, dd, ee, ii,
Musk Thistle* <i>Carduus nutans</i>					X	X	X	
Owl's Clover <i>Castilleja tenuis</i>						X	X	o,
Indian Paintbrush <i>Castilleja spp</i>							X	d, m, o, v, y, cc, dd,

* Non-native species

‡ Not an exhaustive list of nurseries. Use Internet search engine to locate additional suppliers.

SPECIES	Habitat Type								NURSERY‡
	Wetland & Bottomland					Grassland		Oak Woodland & Savanna	
	Shallow Water	Marsh	Shrub Swamp	Bottomland Hardwood	Riparian	Wet Prairie	Upland Prairie		
Meadow knapweed* <i>Centaurea pratensis</i>							X	X	
Bull Thistle* <i>Cirsium vulgare</i>					X	X	X	X	
Canada Thistle* <i>Cirsium arvense</i>					X	X	X	X	
Fairwell to Spring <i>Clarkia amoena</i>							X		o, cc
Siberian Miner's Lettuce <i>Claytonia sibirica</i>				X					
Scouler's Corydalis <i>Corydalis scouleri</i>					X				m, ee,
Menzie's Larkspur <i>Delphinium menziesii</i>							X	X	o, ee,
Tall Larkspur <i>Delphinium troliifolium</i>				X					
Western Bleeding Heart <i>Dicentra Formosa</i>				X	X				f, m, n, o, r, v, y, cc, ee, ii,
Ookow <i>Dichelostemma congesta</i>							X	X	
Shooting Star <i>Dodecotheon hendersonii</i>							X	X	o, r, ee,
Common Downingia <i>Downingia elegans</i>		X			X	X			o, w,
Dense Spike Primrose <i>Epilobium densiflorum</i>		X				X			o, w, cc,
Woolly Sunflower <i>Eriophyllum lanatum</i>						X	X	X	f, m, n, o, r, w, cc, dd,
White Fawn Lily <i>Erythronium oregonum</i>				X			X	X	f, m, n, o, p, r, aa, ii,
Woods Strawberry <i>Fragaria vesca</i>					X	X	X	X	f, m, n, r, v, aa, cc, ee, ii,
Mountain Strawberry <i>Fragaria virginiana</i>						X	X	X	m, r, v, cc
Chocolate Lily <i>Fritillaria lanceolata</i>						X	X	X	n, o, dd, ii,
Bedstraw <i>Galium spp.</i>		X		X	X	X		X	g, o,
Largeleaf Avens <i>Geum macrophyllum</i>						X	X	X	d, f, o,
Common Gilia <i>Gilia capitata</i>							X	X	m, o, w, y, cc, dd,
Lowland Cudweed <i>Gnaphalium palustre</i>						X	X		o,
Gum-weed <i>Grindelia integrifolia</i>						X	X		n, o,

* Non-native species

‡ Not an exhaustive list of nurseries. Use Internet search engine to locate additional suppliers.

SPECIES	Habitat Type							NURSERY‡
	Wetland & Bottomland				Grassland		Oak Woodland & Savanna	
	Shallow Water	Marsh	Shrub Swamp	Bottomland Hardwood	Riparian	Wet Prairie		
Cow Parsnip <i>Heracleum lanatum</i>					X	X	X	n, o, cc, dd, ii,
Yellow Iris* <i>Iris pseudacorus</i>		X	X		X			
Oregon Iris <i>Iris tenax</i>							X	a, e, f, g, m, n, o, r, v, aa, cc, ee, ii,
Duckweed <i>Lemna minor</i>	X	X						ii,
Tiger Lily <i>Lilium columbianum</i>				X			X	g, m, n, o, r, y, aa, cc, dd, ii,
Common Lomatium <i>Lomatium utriculatum</i>							X	o
Spanish Clover <i>Lotus purshianus</i>						X	X	o, w, cc
Money Plant* <i>Lunaria annua</i>				X	X			dd,
Sickle-keeled Lupine <i>Lupinus albicaulis</i>							X	o, y, cc,
Broad-leaf Lupine <i>Lupinus latifolius</i>							X	o, y, cc,
Small-flowered Lupine <i>Lupinus micranthus</i>					X	X	X	m, o, cc,
Large-leaf Lupine <i>Lupinus polyphyllus</i>					X	X		m, n, o, r, v, y, cc, dd, ee,
Stream or Riverbank Lupine <i>Lupinus rivularis</i>					X			f, m, o, w, aa, cc,
Skunk Cabbage <i>Lysichiton americanum</i>		X	X					d, g, ee, ii,
Purple Loosestrife* <i>Lythrum salicaria</i>	X	X	X		X			
Showy Tarweed <i>Madia elegans</i>						X	X	
False Lily-of-the-Valley <i>Maianthemum dilatatum</i>				X				f, g, m, o, ee, ii,
Seep-spring Monkey Flower <i>Mimulus guttatus</i>	X					X	X	f, m, n, o, r, cc, ee, ii,
Five Stamened Mitrewort <i>Mitella pentandra</i>					X			m, ee,
Narrow-leaf Montia <i>Montia linearis</i>	X					X		
Eurasian Milfoil* <i>Myriophyllum spicatum</i>	X	X	X					
Yellow Pond-lily <i>Nuphar lutea</i>	X							
Water Parsley <i>Oenanthe sarmentosa</i>		X	X	X	X	X		d, m, n, o, cc, ii,

* Non-native species

‡ Not an exhaustive list of nurseries. Use Internet search engine to locate additional suppliers.

SPECIES	Habitat Type							NURSERY†‡
	Wetland & Bottomland				Grassland		Oak Woodland & Savanna	
	Shallow Water	Marsh	Shrub Swamp	Bottomland Hardwood	Riparian	Wet Prairie		
Scotch Thistle* <i>Onopordum acanthium</i>					X	X	X	
Mountain Sweetroot <i>Osmorhiza chilensis</i>						X	X	o,
Fragrant Popcornflower <i>Plagiobothrys figuratus</i>	X					X		cc,
English Plantain* <i>Plantago lanceolata</i>						X	X	X
Rosy Plectritis <i>Plectritis congesta</i>						X	X	X
Japanese Knotweed* <i>Polygonum cuspidatum</i>	X	X	X			X		
Waterpepper <i>Polygonum hydropiperoides</i>	X	X						ee,
Willow or Smart Weed <i>Polygonum lapathifolium</i>	X	X				X		
Northwest or Slender Cinquefoil <i>Potentilla gracilis</i>						X	X	X
Pondweed (several species, native & introduced) <i>Potamogeton spp</i>		X						
Self Heal <i>Prunella vulgaris</i> var. <i>lanceolata</i>						X	X	X
Water Crowfoot <i>Ranunculus aquatilis</i>	X	X	X			X		
Western Buttercup <i>Ranunculus occidentalis</i>							X	X
Bird-beak buttercup <i>Ranunculus orthorhynchus</i>						X		
Creeping Buttercup* <i>Ranunculus repens</i>		X	X			X		
Watercress* <i>Rorippa nasturtium-aquaticum</i>	X	X	X		X			
Sheep Sorrel* <i>Rumex acetosella</i>						X	X	X
Curled Dock* <i>Rumex crispus</i>						X	X	X
Western Dock <i>Rumex occidentalis</i>						X	X	X
Willow Dock <i>Rumex salicifolius</i>		X			X	X		
Wapato <i>Sagittaria latifolia</i>		X						
Small Burnet <i>Sanguisorba annua</i>						X	X	X
Oregon Saxifrage <i>Saxifraga oregano</i>						X		

* Non-native species

‡ Not an exhaustive list of nurseries. Use Internet search engine to locate additional suppliers.

SPECIES	Habitat Type							NURSERY‡	
	Wetland & Bottomland				Grassland		Oak Woodland & Savanna		
	Shallow Water	Marsh	Shrub Swamp	Bottomland Hardwood	Riparian	Wet Prairie			Upland Prairie
Tansy Ragwort* <i>Senecio jacobaea</i>					X	X	X	X	
Meadow Checkermallow <i>Sidalcea campestris</i>						X	X		m, r, ii
Checker Mallow <i>Sidalcea virgata</i>							X	X	r, w
Blue-eyed Grass <i>Sisyrinchium idahoense</i>						X	X	X	g, n, r, y, ee, ii,
False Solomon's Seal <i>Smilacina racemosa</i>				X					g, m, n, o, r, cc, ee, ii,
Star-flowered False Solomon's Seal <i>Smilacina stellata</i>				X					m, n, r, dd, ee, ii,
Canadian Goldenrod <i>Solidago Canadensis</i>							X	X	f, m, o, v, w, cc, dd,
Bur-reed <i>Sparganium emersum</i>	X	X							a, d, l,
Duckweed, Greater & Common <i>Spirodela poylrhiza & Lemna minor</i>	X	X							
Hedge Nettle <i>Stachys cooleyae</i>			X	X	X				
Alaska Fringecup or Fringe Cups <i>Tellima grandiflora</i>				X				X	f, m, n, o, ee, ii,
Western Meadowrue <i>Thalictrum occidentale</i>				X				X	g, m, ee,
Tall meadow-rue <i>Thalictrum polycarpum</i>				X		X			
Foamflower <i>Tiarella trifoliata</i>				X					g, m, o, ee,
Piggy-back Plant <i>Tolmiea menziesii</i>				X	X			X	m, o, ee, ii,
Field Hedge-parsley* <i>Torilis arvensis</i>				X	X	X	X	X	
Pacific Coast Trillium <i>Trillium ovatum</i>				X					f, g, m, n, r, cc, ee, ii,
Narrow-leaf Cattail* <i>Typha angustifolia</i>	X	X							l, ee
Common Cattail <i>Typha latifolia</i>	X	X							a, d, f, l, m, n, o, v, y, aa, cc, dd, ee, ii
Stinging Nettle <i>Urtica dioica</i>				X	X				
Bladderwort <i>Utricularia macrorhiza</i>	X	X							
Inside-out Flower <i>Vancouveria hexandra</i>				X					m, n, ee, ii,
False-Hellebore <i>Veratrum californicum var. caudatum</i>	X			X					

* Non-native species

‡ Not an exhaustive list of nurseries. Use Internet search engine to locate additional suppliers.

SPECIES	Habitat Type							NURSERY‡
	Wetland & Bottomland				Grassland		Oak Woodland & Savanna	
	Shallow Water	Marsh	Shrub Swamp	Bottomland Hardwood	Riparian	Wet Prairie		
American Speedwell <i>Veronica Americana</i>		X				X		m, n, o,
Marsh Speedwell <i>Veronica scutellata</i>	X	X				X		o,
Oval-leafed Viburnum <i>Viburnum ellipticum</i>				X	X		X	m
American Vetch <i>Vicia Americana</i>						X	X	cc
Early Blue Violet <i>Viola adunca</i>							X	X
Yellow Violet <i>Viola glabella</i>				X				m, ee, ii,
Wood Violet <i>Viola sempervirens</i>				X				m, ee,
Narrow-leaf Wyethia <i>Wyethia angustifolia</i>						X	X	X
Death Camas <i>Zygadenus venenosus</i>						X		X
Grasses and Sedges:								
Lemmon's Needlegrass <i>Achnatherum lemmonii</i>							X	X
Slender Wheatgrass <i>Agropyron (Elymus) trachycaulum</i>							X	X
Redtop* <i>Agrostis capillaris</i>						X	X	X
Spike Bentgrass <i>Agrostis exarata</i>					X	X		
Creeping Bentgrass* <i>Agrostis stolonifera</i>				X	X	X		
Meadow Foxtail* <i>Alopecurus pratensis</i>	X	X			X	X		
Water Foxtail <i>Alopecurus geniculatus</i>		X			X	X		
American Sloughgrass <i>Beckmannia syzigachne</i>	X	X	X			X		
False-brome* <i>Brachypodium sylvaticum</i>				X	X		X	X
California Brome <i>Bromus carinatus</i>					X		X	X
Soft Brome* <i>Bromus hordeaceus</i>						X		
Smooth Brome* <i>Bromus inermis</i>						X		

* Non-native species

‡ Not an exhaustive list of nurseries. Use Internet search engine to locate additional suppliers.

SPECIES	Habitat Type							NURSERY‡	
	Wetland & Bottomland				Grassland		Oak Woodland & Savanna		
	Shallow Water	Marsh	Shrub Swamp	Bottomland Hardwood	Riparian	Wet Prairie			Upland Prairie
Sitka Brome <i>Bromus sitchensis</i>					X			X	o, w, cc, dd,
Columbia Brome <i>Bromus vulgaris</i>								X	o, w, cc,
Bluejoint <i>Calamagrostis canadensis</i>					X				dd, cc,
Big-leaf Sedge <i>Carex amplifolia</i>		X		X	X	X			n, v, cc, dd,
Columbia Sedge <i>Carex aperta</i>			X		X				n, cc, ee,
Dense Sedge <i>Carex densa</i>	X	X				X			a, d, f, m, n, cc, ii,
Short-scale or Dewey Sedge <i>Carex deweyana</i>				X	X			X	a, d, n, cc, ee, ii,
Green-sheathed Sedge <i>Carex feta</i>		X				X			o,
Henderson's Sedge <i>Carex hendersonii</i>				X					
Harefoot Sedge <i>Carex leporina</i>		X	X		X	X			o, cc,
Slough Sedge <i>Carex obnupta</i>		X	X	X	X				a, c, d, e, f, l, m, n, o, y, cc, ee, ii,
Beaked Sedge <i>Carex rostrata</i>		X	X	X	X				n, o, v, y, cc, dd,
Sawbeak Sedge <i>Carex stipata</i>				X	X	X			a, d, e, n, w, cc, dd, ee, ii,
Foothill Sedge <i>Carex tumulicola</i>							X	X	
One-sided Sedge <i>Carex unilateralis</i>		X				X			d, o, ee, ii,
Inflated Sedge <i>Carex vesicaria</i>	X	X							n, v, cc, dd,
Other Sedges <i>Carex spp.</i>		X		X	X	X			
Hedgehog Dogtail* <i>Cynosurus echinatus</i>							X	X	
Yellow Nutsedge* <i>Cyperus esculentus</i>		X				X			
Orchard Grass* <i>Dactylis glomerata</i>				X	X	X		X	
California Oatgrass <i>Danthonia californica</i>						X	X	X	o, cc, dd, ee,
Tufted Hairgrass <i>Deschampsia cespitosa</i>	X	X				X			d, f, l, n, o, r, w, y, aa, cc, dd, ee, ii,
Annual Hairgrass <i>Deschampsia danthoniodes</i>						X			

* Non-native species

‡ Not an exhaustive list of nurseries. Use Internet search engine to locate additional suppliers.

SPECIES	Habitat Type							NURSERY‡
	Wetland & Bottomland				Grassland		Oak Woodland & Savanna	
	Shallow Water	Marsh	Shrub Swamp	Bottomland Hardwood	Riparian	Wet Prairie		
Slender Hairgrass <i>Deschampsia elongate</i>		X			X	X	X	w, y, cc,
Dulichium <i>Dulichium arundinaceum</i>	X	X	X					
Spike-rush <i>Eleocharis acicularis</i>		X			X	X		n, y, cc,
Ovid Spikerush <i>Eleocharis obtusa</i>		X			X	X		m, n, cc,
Common or creeping Spikerush <i>Eleocharis palustris</i>	X	X	X			X		a, d, e, l, n, o, v, w, cc, dd, ee, ii,
Western or Blue Wildrye <i>Elymus glaucus</i>					X		X	n, o, w, y, cc, dd,
Quackgrass* <i>Elytrigia repens</i>		X			X	X	X	
Tall Meadow Fescue* <i>Festuca arundinacea</i>				X	X	X	X	
California Fescue <i>Festuca californica</i>							X	cc, ee,
Roemer's Fescue <i>Festuca roemeri</i>						X	X	n, o, r, w, y, cc, dd,
Western Mannagrass <i>Glyceria spp.</i>	X	X				X		o, y, cc, dd, ii,
Common Velvetgrass* <i>Holcus lanatus</i>					X	X	X	
Meadow Barley <i>Hordeum brachyantherum</i>		X				X		o, w, y, cc, dd, ee,
Tapered Rush <i>Juncus acuminatus</i>	X	X				X		o, ee, ii,
Baltic Rush <i>Juncus balticus</i>	X	X	X					d, e, n, o, v, y, cc, dd, ee, ii,
Bolander's Rush <i>Juncus bolanderi</i>		X	X			X		n, o, cc,
Toad Rush <i>Juncus bufonius</i>	X	X			X	X		w, cc,
Soft Rush* (some vars native) <i>Juncus effusus</i>		X		X	X	X		a, c, d, e, f, g, l, m, n, o, y, cc, dd, ee, ii,
Dagger-leaf Rush <i>Juncus ensifolius</i>	X	X	X					d, e, f, m, n, o, v, y, cc, dd, ee, ii,
Pointed Rush <i>Juncus oxymiris</i>		X	X		X	X		d, o, ii,
Grooved Rush <i>Juncus patens</i>		X	X		X	X		d, e, f, m, o, cc, ee, ii,
Slender Rush <i>Juncus tenuis</i>					X	X	X	n, o, y, cc, ii,
Junegrass <i>Koeleria macrantha</i>						X	X	dd, gg,

* Non-native species

‡ Not an exhaustive list of nurseries. Use Internet search engine to locate additional suppliers.

SPECIES	Habitat Type							NURSERY‡	
	Wetland & Bottomland				Grassland		Oak Woodland & Savanna		
	Shallow Water	Marsh	Shrub Swamp	Bottomland Hardwood	Riparian	Wet Prairie			Upland Prairie
Rice Cut-grass <i>Leersia oryzoides</i>		X		X	X			y, cc,	
Perennial Ryegrass* <i>Lolium perenne</i>				X	X	X	X	X	
Annual Ryegrass* <i>Lolium multiflorum</i>				X	X	X	X	X	
Reed Canarygrass* <i>Phalaris arundinacea</i>		X	X	X	X	X			
Cultivated or Pasture Timothy* <i>Phleum pratense</i>						X	X	X	
Common Reed <i>Phragmites communis</i>		X			X				cc, dd,
Kentucky Bluegrass* <i>Poa pratensis</i>						X	X	X	
Hardstem "Tule" Bulrush <i>Scirpus acutus</i>	X	X	X						a, c, d, e, l, m, n, o, v, y, cc, dd, ee, ii,
Three-square Bulrush <i>Scirpus americanus</i>		X	X						d, l, n, o, v, cc, dd, ee, ii,
Small-fruited Bulrush <i>Scirpus microcarpus</i>		X	X		X				a, d, e, f, l, m, n, o, v, y, cc, dd, ee, ii,
Soft-stem "Tule" Bulrush <i>Scirpus tabernaemontani (s. validus)</i>	X	X	X						d, l, o, v, y, cc, dd
Broad-fruited Burreed <i>Sparaganium eurycarpum</i>		X	X	X					o, v, dd, ee,
Johnsongrass* <i>Sorghum halepense</i>						X	X		
Medusahead Rye* <i>Taeniatherum caput-medusae</i>					X		X	X	
Small Fescue <i>Vulpa microstachys</i>							X	X	
Foxtail Fescue* <i>Vulpa myuros</i>							X	X	
Ferns and Horsetails:									
Maidenhair Fern <i>Adiantum aleuticum</i>				X	X				f, l, m, r, ee, ii,
Lady Fern <i>Athyrium filix-femina</i>			X	X	X				d, f, g, l, m, o, r, ee, ii,
Giant Horsetail <i>Equisetum telmateia</i>				X	X				
Common Scouring-rush <i>Equisetum hyemale</i>			X	X	X				ee,
Sword Fern <i>Polystichum munitum</i>				X	X				m, ee, ii
Native Straw									w

* Non-native species

‡ Not an exhaustive list of nurseries. Use Internet search engine to locate additional suppliers.

NATIVE PLANT NURSERIES[†]

(Compiled from Oregon Association of Nuserymen directory,¹⁰⁶ nursery flyers, and nursery web pages)

<p>a. Valley Growers Nursery PO Box 610 30570 S. Barlow Rd. Hubbard, OR 97032 (503) 651-3535, FAX (503) 651-3044 http://www.valleygrowers.com vlygrwrs@europa.com</p>	<p>b. Aurora Forest Nursery Weyerhaeuser Company 6051 S. Lone Elder Rd. Aurora, OR 97002 (503) 266-2018, FAX (503) 266-2010 mark.triebwasser@weyerhauser.com</p>
<p>c. Alder View Natives 28315 Grahams Ferry Wilsonville, OR 97070 (503) 570-2894, FAX (503) 570-9904</p>	<p>d. Balance Restoration Nursery 27995 Chambers Mill Rd. Lorane, OR 97451 (541) 942-5530, FAX (541) 942-5530 tamfrobson@cs.com</p>
<p>e. Beaverpond Natives 48070 NW John Lee Rd. Buxton, OR 97109 (503) 324-5067, FAX (503) 324-5067 cokrduggan@earthlink.net</p>	<p>f. Bosky Dell Natives, Inc. 23311 SW Bosky Dell Ln. West Linn, OR 97068 (503) 638-5945, FAX (503) 638-8047 boskydellnatives@aol.com</p>
<p>g. Carter's Greenhouse & Nursery 5145 Waymire Rd. Dallas, OR 97338 (503) 787-3371, FAX (503) 787-1502</p>	<p>h. Cascadian Nurseries, Inc. 13495 NW Thompson Rd. Portland, OR 97229 (503) 645-3350, FAX (503) 645-0333 http://www.cascadiannurseries.com sales@cascadiannurseries.com</p>
<p>j. D.L. Phipps Forest Nursery # Oregon Dept. of Forestry 2424 Wells Rd. Elkton, OR 97436 (541) 584-2214, FAX (541) 584-2326 http://www.odf.state.or.us/Nursery</p>	<p>k. D & R Nurseries 5802 SW Knightsbridge Dr. Portland, OR 97219 (503) 452-3387, FAX, (503) 452-3197 drnursery@teleport.com</p>
<p>l. Eby Nursery Inc. PO Box 1127 5621 SW Homesteader Rd. Wilsonville, OR 97070 (503) 638-8222, FAX (503) 638-3848 bceby@teleport.com</p>	<p>m. Echo Valley Natives 18883 S. Ferguson Rd. Oregon City, OR 97045 (503) 655-5885 echovalleynative@aol.com</p>
<p>n. Fourth Corner Nurseries # 3057 E. Bakerview Rd. Bellingham, WA 98226 (800) 416-8640, FAX (360) 592-4323 http://www.4th-corner-nurseries.com sales@4thcorner-nurseries.com</p>	<p>o. Frosty Hollow Ecological Restoration # Box 53 Langley, WA 98260 (360) 579-2332, FAX (360) 579-4080 wean@whidbey.net</p>
<p>p. Heritage Seedlings, Inc. 4199 75th Ave. SE Salem, OR 97301 (503) 585-9835, FAX (503) 371-9688 http://www.heritageseedlings.com sales@heritageseedlings.com</p>	<p>q. Kintigh's Mountain Home Ranch 38865 E. Cedar Flat Rd. Springfield, OR 97478 (541) 746-1842, FAX (541) 746-1842</p>

[†] Listing of these nurseries or suppliers is not an endorsement.

Nurseries outside of the Willamette Valley

r. Mahonia Vineyards & Nursery Inc. 4985 Battle Creek Rd., Ste. 205 Salem, OR 97302 (503) 585-8789, FAX (503) 363-2358 http://www.mahonianursery.com wildwoodco@aol.com	s. Meadow Lake Nursery PO Box 1302 3500 NE Hawn Creek Road McMinnville, OR 97128 (503) 435-2000, FAX (503) 435-1312 http://www.meadow-lake.com info@meadow-lake.com
t. Milestone Nursery # PO Box 907 Lyle, WA 98635 (509) 365-5222, FAX (509) 365-4245 milestone@gorge.net	u. Native Habitat Nursery 14140 SE Palmer Creek Rd. Dayton, OR 97114 (503) 864-4800
v. Plants of the Wild # P.O. Box 866 Tekoa, WA 99033 (509) 284-2848 http://www.plantsofthewild.com	w. Pacific Northwest Natives 1525 Laurel Heights Dr. NW Albany, OR 97321 (541) 928-8239, FAX (541) 924-8855 cwe@proaxis.com
x. Qualitree, Inc. 11110 Harlan Rd. Eddyville, OR 97343 (541) 875-4192 riskink@harborside.com	y. Rainier Seeds, Inc. # PO Box 1064 1404 Fourth St. Davenport, WA 99122 (800) 828-8873, FAX (509) 725-7015 http://www.rainierseed.com rainierseeds@rainierseeds.com
z. River Rock Nursery 19251 SE Highway 224 Clackamas, OR 97015 (503) 658-4047 http://www.riverrocknursery.com gree@agora.rdrop.com	aa. Sevenoaks Native Nursery 29730 Harvest Dr. SW Albany, OR 97321 (541) 757-6520, FAX (541) 757-6520 sevenoakn@aol.com
cc. Sunmark Seeds 845 NW Dunbar Ave. #101 Troutdale, OR 97060 (888) 214-7333, FAX (503) 491-0279 http://www.sunmarkseeds.com seeds@sunmarkseeds.com	dd. Sun Mountain Native Seed # 120 North Wall St., Ste 400 Spokane, WA 99201 (509) 835-4967 or (800) 286-0180 http://www.sunmountainseeds.com
ee. Trillium Gardens PO Box 803 Pleasant Hill, OR 97455 (541) 937-3073, FAX (541) 937-2261 http://www.trilliumgardens.com shelia@trilliumgardens.com	ff. Watershed Garden Works# 2039 44 th Ave. Longview, WA 98632 (360) 423-6456, FAX (360) 423-6456 http://www.watershednursery.com
gg. Wildlands, Inc. # 1941 Saint St. Richland, WA 99352 (800) 288-8328, FAX (509) 375-4717 http://www.wildlands-inc.com wildland@gte.net	hh. Wind Hill Native Gardens PO Box 789 15755 NW Wind Hill Dr. Banks, OR 97106 (503) 324-6870, (503) 324-4917 nature@intermetcds.com
ii. Wallace W. Hansen Nursery & Gardens 2158 Bower Ct. SE Salem, OR 97301 (503) 581-2638, FAX (503) 9957 http://www.nwplants.com plants@nwplants.com	

† Listing of these nurseries or suppliers is not an endorsement.

Nurseries outside of the Willamette Valley

Appendix B:

Seeding Rates and Depths for Some Common Native Plants^{83,84}

Common Name	Seeding Rate (lbs. per acre)	Seeding Depth (inches)
Serviceberry	0.5-1.0 lbs.	<0.51
Red-osier Dogwood	0.25-0.5	0.25-0.5
Black or Douglas Hawthorn	0.5-1.0	0.25-0.5
Chokecherry	1.0-2.0	0.5-1.0
Currant	<1.0	0.16-0.25
Wild Roses	0.5-1.0	0.5
Willow Species	N/A	surface
Common Snowberry	1.0-3.0	surface-0.5
White Yarrow	1.0	<0.5*
Red Columbine	4.0-6.0	<0.5*
Arrowleaf Balsamroot	6.0-8.0	1.0*
Camas	8.0	<0.5
Twin Flower	6.0-8.0	1.0*
Dense Spike Primrose	4.0-6.0	<0.5*
Western Bleeding Heart	4.0-6.0	<0.5*
Globe Gilia	1.0	<0.5
Tiger Lily	tuber	n.a.
Blue Flax	6.0	1.0*
Sickle-keeled Lupine	10.0	1.0*
Large-leaf Lupine	8.0	1.0*
Riverbank Lupine	6.0-10	1.0*

Common Name	Seeding Rate (lbs. per acre)	Seeding Depth (inches)
Seep-spring Monkey Flower	0.25	<0.5*
Small Burnet	20-24	1.0*
Common Cattail	2.0	<0.5*
Slender Wheatgrass	6.0-8.0	1.0*
Spike Bentgrass	2.0-5.0	<0.5
American Sloughgrass	19.0	<0.5*
California Brome	6.0-8.0	1.0*
Sitka Brome	7.0-20	<0.5*
Smooth Brome	8.0	1.0*
Water or Aquatic Sedge	1.0-2.0	<0.5*
Slough Sedge	1.0	<0.5*
Beaked Sedge	1.0-2.0	<0.5*
Tufted Hairgrass	1.0-2.0	<0.5*
Slender Hairgrass	1.0-2.0	<0.5*
Blue Wildrye	10.0	1.0*
Roemer's Fescue	8.0	<0.5*
Western Mannagrass	6.0-8.0	1.0*
Meadow Barley	10-30	1.0*
Baltic Rush	1.0	<0.5*
Dagger-leaf Rush	1.0	<0.5*
Slender Rush	1.0	<0.5*
Hardstem Bulrush	4.0	<0.5*

* Estimated planting depth based on USDA Plant Materials Tech Note MT-31.⁸³

Appendix C: _____

List of State and Federal Incentive Programs

NAME	ORGANIZATION	TYPE OF INCENTIVE
Access & Habitat Program	Oregon Department of Fish and Wildlife	<p>Goal: Improve wildlife habitat and provide hunter access to private lands in Oregon. Grant of ≤100%, cost-sharing not required but priority when competition for grant money.</p> <p>Website: www.dfw.state.or.us/ODFWhtml/Wildlife/ahpgm.html</p>
Fish Restoration & Enhancement Program	Oregon Department of Fish and Wildlife	<p>Goal: Restore state-owned fish hatcheries, enhance hatchery production, and provide additional public access to fishing waters in Oregon. Grant of ≤100%, cost-sharing not required but priority when competition for grant money.</p> <p>Website: www.dfw.or.us/ODFWhtml/InfoCntrFish/RnEProgram/R%26EHistory.html</p>
Oregon 25% Tax Credit for Fish Habitat Improvement	Oregon Department of Fish and Wildlife	<p>Goal: Improve fish habitat and prevent the loss of fish in irrigation canals. 25% of the cost for voluntary fish habitat improvements can be credited on state income tax.</p> <p>Website: www.leg.state.or.us/ors/315.html</p>
Riparian Lands Tax Incentive Program	Oregon Department of Fish and Wildlife	<p>Goal: Protect, conserve, or restore healthy riparian habitat on private lands adjacent to perennial or intermittent streams. Remove up to 100' on each side of water body from tax role.</p> <p>Website: www.dfw.state.or.us/ODFWhtml/InfoCntrHbt/InfoCntrHbt.html (see Riparian Lands Tax Incentive Program)</p>
Wildlife Habitat Conservation & Management Program	Oregon Department of Fish and Wildlife	<p>Goal: Help private landowners develop plans to create, improve, or protect habitat for native fish & wildlife. Property is taxed at a low rate.</p> <p>Website: www.dfw.state.or.us/ODFWhtml/InfoCntrHbt/InfoCntrHbt.html (see Wildlife Habitat Conservation and Management Program)</p>

* Funding for grant programs may be limited and contingent upon appropriation of funds by the state legislature or federal congress.

NAME	ORGANIZATION	TYPE OF INCENTIVE
Forest Resource Trust	Oregon Department of Forestry	<p>Goal: Encourage landowners to establish and maintain healthy forests. Grant $\leq 100\%$ total costs.</p> <p>Website: www.odf.state.or.us/DIVISIONS/management/forestry_assistance/trust/default.asp?id=50201040203</p>
Oregon Reforestation Tax Credit	Oregon Department of Revenue	<p>Goal: Reforestation of under-productive forestland in Oregon that is not regulated by the Oregon Forest Practices Act. An Oregon income tax credit for 15% of reasonable project costs.</p> <p>Website: www.odf.state.or.us/DIVISIONS/management/forestry_assistance/taxes/taxpgms.asp?id=3020104</p>
Watershed Enhancement Program	Oregon Watershed Enhancement Board	<p>Goal: Enhance Oregon's waters through the management of riparian and associated upland areas to improve water quality and quantity. Grant $\leq 75\%$ total cost with remainder cost-shared by landowner or other partners.</p> <p>Website: www.oweb.state.or.us</p>
Partners for Fish & Wildlife	U.S. Fish & Wildlife Service	<p>Goal: Help private landowners voluntarily restore wetlands or other fish & wildlife habitats on their land. Grant of 50% total cost with landowner cost-sharing remainder.</p> <p>Website: http://partners.fws.gov/</p>
Forest Land Enhancement Program	USDA Forest Service	<p>Goal: Improve forest stands, water quality and wildlife habitat; protect watersheds; wildfire and catastrophic risk reduction; wildfire and catastrophic event rehabilitation; and road maintenance, renovation and restoration. Grant cost share ranges from 50-75%, depending on fund availability.</p> <p>Website: www.odf.state.or.us/divisions/management/forestry_assistance/default.asp?id=3020104</p>
Federal 10% Reforestation Income Tax Credit	Internal Revenue Service	<p>Goal: Reforest lands. Allows 10% of direct costs incurred in establishing a stand of timber from federal income tax.</p> <p>Website: http://ftp.fedworld.gov/pub/irs_pdf/p225.pdf</p>
Environmental Quality Incentives Program (EQIP)	USDA, NRCS	<p>Goal: Conserve soil, water, and related natural resources. Grant $\leq 75\%$ total cost with landowner cost-sharing remainder.</p> <p>Website: www.nrcs.usda.gov/programs/eqip/</p>

* Funding for grant programs may be limited and contingent upon appropriation of funds by the state legislature or federal congress.

NAME	ORGANIZATION	TYPE OF INCENTIVE
Grasslands Reserve Program	USDA, NRCS	<p>Goal: Restore and protect plant and animal biodiversity on grasslands and shrublands while maintaining the areas as grazing lands. Easements (10 – 30 years) provide up to 75% of annual grazing value.</p> <p>Website: www.or.nrcs.usda.gov/programs/grp.html</p>
Wetlands Reserve Program	USDA, NRCS	<p>Goal: Restore and protect wetlands on private property. Grant for permanent easement of 100% or 75% for restoration agreement with landowner or other partners cost-sharing remainder.</p> <p>Website: www.nrcs.usda.gov/programs/wrp/</p>
Wildlife Habitat Incentive Program	USDA, NRCS	<p>Goal: Establish and improve fish and wildlife habitat on private lands. Grant of ≤75% total cost with landowner or other partners cost-sharing remainder.</p> <p>Website: www.nrcs.usda.gov/programs/whip/</p>
Conservation Reserve Program	USDA, NRCS	<p>Goal: Improve the nation's natural resources by placing highly erodible and other environmentally sensitive pasture or cropland into conservation practices that reduce soil erosion, improve water quality, and enhance wildlife habitat. Farmers receive an annual rental payment for the term of the multi-year contract. Cost sharing is provided to establish the vegetative cover practices.</p>
Landowner Incentive Program	ODFW, USFWS	<p>Goal: Protect and restore habitats on private lands, to benefit federally listed, proposed or candidate species determined to be at-risk, and provide technical and financial assistance to private landowners for habitat protection and restoration. Requires 25% non-federal match.</p> <p>Contact: ODFW Lands Resources Program 503-947-6301</p>

* Funding for grant programs may be limited and contingent upon appropriation of funds by the state legislature or federal congress.

Appendix D:

Sources of Information and Assistance

STATE AGENCIES

Oregon Department of Fish and Wildlife

Headquarters
3406 Cherry Avenue NE
Salem, OR 97207
503 / 947-6000
www.dfw.state.or.us

Northwest Regional Office
17330 SE Evelyn St.
Clackamas, OR 97015
(503) 657-2000

North Willamette Watershed Wildlife District
18330 NW Sauvie Island Road
Portland, OR 97231
Tel: (503) 621-3488 Fax: (503) 621-3025

Oregon Department of Forestry

Salem Headquarters
2600 State Street
Salem, Oregon 97310
Tel. (503) 945-7200 Fax: (503) 945-7212
www.odf.state.or.us/

Northwest Oregon Area Office
801 Gales Creek Road
Forest Grove, Oregon 97116-1199
Tel. (503) 357-2191

Forest Grove District
801 Gales Creek Road
Forest Grove, Oregon 97116-1199
Tel. (503) 357-2191

South Willamette Watershed District Office
7118 NE Vanderberg Avenue
Corvallis, OR 97330-9446
Tel: (541) 757-4186 Fax: (541) 757-4252

Salem Field Office
4412 Silverton Road NE
Salem, OR 97305-2060
Tel: (503) 378-6925 Fax: (503) 378-6233

Springfield Field Office
3150 E Main Street
Springfield, OR 97478-5800
Tel: (541) 726-3515 Fax: (541) 726-2505

Dallas Unit
825 Oak Villa Rd
Dallas OR 97338
Tel. (503) 623-8146

Western Lane District
P.O. Box 157
Veneta, Oregon 97487-0157
Tel. (541) 935-2283

Eastern Lane District
3150 Main Street
Springfield, Oregon 97478
Tel. (541) 726-3588

Oregon Department of Forestry, *continued*

Clackamas-Marion District
14995 S. Hwy. 211
Molalla, Oregon 97038
Tel. (503) 829-2216

West Oregon District
24533 Alsea Hwy.
Philomath, Oregon 97370
Tel. (541) 929-3266

Linn District
4690 Highway 20
Sweet Home, Oregon 97386
Tel. (541) 367-6108

Santiam Unit
22965 North Fork Rd SE
Lyons OR 97358
Tel. (503) 859-2151

Oregon Department of Agriculture

Salem Headquarters
635 Capitol St. NE
Salem, OR 97301
Tel. (503) 986-4550
www.oda.state.or.us

Grants
635 Capitol St. NE
Salem, OR 97310
Tel. (503) 986-4558

Natural Resources Division
635 Capitol St. NE
Salem, Oregon 97301
Tel. (503) 986-4700

Pesticides Division
635 Capitol St. NE
Salem OR 97301
Tel. (503) 986-4635

Plant Division
635 Capitol St. NE
Salem, OR 97301
Nursery & Christmas Tree Program
Tel. (503) 986-4644
Plant Pest & Disease Programs: (503) 986-4636
Invasive Species Hotline: 1-866-INVADER

Noxious Weed Control Program
635 Capitol St. NE
Salem, OR 97310
Tel. (503) 986-4621

Oregon Land Conservation and Development Commission

Salem Office
635 Capitol St. NE, Suite 150
Salem, OR 97301
Tel. (503) 373-0050
www.lcd.state.or.us

Portland Office
800 NE Oregon St. #18 Ste 1145
Portland OR 97232
Tel. (503) 731-4065

Oregon Division of State Lands

775 Summer St. N.E., Suite 100
Salem, OR 97301
Tel. (503)378-3805
www.oregonstatelands.us

Oregon Water Resources Department

Director's Office
158 12th ST. NE
Salem, OR 97301
Tel. (503)378-8455
www.wrd.state.or.us

Northwest Regional Office
158 12th St. NE
Salem, Oregon 97301
Tel. (503) 378-8455, Ext. 220

Northwest Water Districts Regional Manager
158 12th St. NE
Salem, Oregon 97301
Tel. (503) 378-8455, Ext. 375

District 2
Central Lane Justice Court
220 N. 5th St.
Springfield, OR 97477
Tel. (541) 682-3620

District 18
1400 SW Walnut, St #240
Hillsboro, OR 97123
Tel. (503) 846-7780

District 20
1678 S Beavercreek Rd., St. L
Oregon City, OR 97045
Tel. (503) 722-1410

Oregon Watershed Enhancement Board

Salem Headquarters
775 Summer St. NE, Suite 360
Salem, OR 97301
Tel. (503) 986-0181
www.oweb.state.or.us

Willamette Basin Regional Office
775 Summer Street NE, Suite 360
Salem, OR 97301
Tel. (503) 986-0185

Established Willamette Basin Watershed Councils

Calapooia Watershed Council
3225 Hwy 20
Sweet Home, OR 97386
Tel. (541) 367-6735
E-Mail: calapooia@centurytel.net

North Santiam Watershed Council
311 N. Third Ave.
Stayton OR 97383
Tel. (503) 767-3284
E-Mail: nsantiam@open.org

Clackamas Watershed Council
PO Box 1869
Clackamas OR 97015
Tel. (503) 650-1256 Fax: (503) 657-8955
E-Mail: crbc@clackamasriver.org

Pedee/Ritner Creek Watershed Council
12503 Pedee Cr. Rd.
Monmouth OR 97361
Tel. (503) 838-5126x
E-Mail: wombatsyn@proaxis.com

Coast Fork Willamette Watershed Council
28 South 6th St Ste A
Cottage Grove OR 97424
Tel. (541) 767-9717
Fax: E-Mail: jmjfalzone@cs.com

Pringle Creek Watershed Council
3867 Wolverine St. NE, Suite 16
Salem OR 97305
Tel. (503) 566-4034
E-Mail: bob-roth@open.org

Johnson Creek Watershed Council
PO Box 82584
Portland OR 97282
Tel. (503) 239-3932
E-Mail: david@jcwec.org

Pudding River Watershed Council
PO Box 398
Scotts Mills OR 97375
Tel (503) 873-6457
E-Mail: scott-eden@or.nacdnet.org

Established Willamette Basin Watershed Councils, *continued*

Long Tom Watershed Council
751 S Danebo Ave
Eugene OR 97402
Tel. (541) 683-6578
E-Mail: longtom@efn.org

Lost Creek Watershed Council
PO Box 27
Lowell OR 97452
Tel. (541) 937-2280
E-Mail: mfwwc@efn.org

Luckiamute Watershed Council
9775 Hultman Rd.
Independence, OR 97351
Tel. (503) 838-4886
E-Mail: arklevta@open.org
luckwatershed@hotmail.com

Mary's River Watershed Council
PO Box 1041
Corvallis, OR 97339
Tel. (541) 758-7597
E-Mail: sandrac@peak.org

McKenzie River Watershed Council
PO Box 53
Springfield OR 97477
Tel. (541) 687-9076
E-Mail: jthrail@callatg.com

Middle Fork Willamette Watershed Council
PO Box 27
Lowell OR 97452
Tel. (541) 937-9800
E-Mail: mfwwc@efn.org

Mowhawk River Watershed Council
PO Box 615
Marcola, OR 97454
Tel. (541) 744-9614x
E-Mail: kohl@pacinfo.com

Soil & Water Conservation Districts

Benton SWCD
305 SW C Ave, Suite 2,
Corvallis, OR 97333
(541) 753-7208, Fax (541) 753-1871
Email: bentoncd@peak.org
www.peak.org/~bentoncd/

Rickreall Creek Watershed Council
580 Main Street Suite A
Dallas, OR 97338
Tel (503) 623-9680x110
E-Mail: rickreallwc@hotmail.com

South Santiam Watershed Council
3225 Highway 20
Sweet Home, OR 97386
Tel. (541) 367-5564
E-Mail: sswc@centurytel.net

Salem/Keizer Area Watershed Council
3867 Wolverine St. NE, Suite 16
Salem OR 97305
Tel (503) 566-4034
E-Mail: bob-roth@open.org

Sandy Basin Watershed Council
PO Box 868
Sandy OR 97055
Tel. (503) 668-1646
E-Mail: rplaeager@yahoo.com

Tualatin Watershed Council
1080 SW Baseline Bldg B Ste B-2
Hillsboro OR 97123
Tel. (503) 648-3174x116
E-Mail: tualatinwc@yahoo.com

Yamhill River Watershed Council
2200 W 2nd St.
McMinnville OR 97128
Tel. (503) 472-6403
E-Mail: Jeff-Bash@or.nacdnet.org

Marion SWCD
3867 Wolverine St NE, Suite 16
Salem, OR 97305-4267
(503) 391-9927, Fax (503) 399-5799
Email: mariswcd@open.org
www.open.org/~mariswcd/

Soil & Water Conservation Districts, *continued*

Clackamas Co. SWCD
256 Warner Milne Rd.
Oregon City, OR 97045
Tel. (503) 656-3499 Fax (503) 650-2367
www.cc-swcd.org/

East Lane SWCD
1600 Valley River Dr., Suite 230
Eugene, OR 97401
(541) 465-6436, Fax (541) 465-6483

East Multnomah SWCD
2701 NW Vaughn St, Suite 450
Portland, OR 97210
(503) 222-SOIL, Fax (503) 326-3942

Linn SWCD
33630 McFarland Rd.
Tangent, OR 97389
(541) 967-5927 ext. 111, Fax (541) 928-9345

Polk SWCD
580 Main St., Suite A
Dallas, OR 97338
(503) 623-9680, Fax (503) 623-6335

Washington County SWCD
1080 SW Baseline, Bldg B, Suite B-2 Hillsboro, OR
97123-3823
(503) 648-3174 ext. 4, Fax (503) 640-1332,
www.swcd.net/

West Multnomah SWCD
2701 NW Vaughn St, Suite 450
Portland, OR 97210
(503) 238-4775, Fax (503) 326-3942
www.westmultconserv.org/

Yamhill SWCD
2200 W 2nd
McMinnville, OR 97128
(503) 472-6403, Fax (503) 472-2459

Oregon State University

Extension Service
Ballard Extension 101
Oregon State University
Corvallis, OR
Tel. (541) 737-4423
<http://extension.oregonstate.edu>

Benton County Extension
1849 NW 9th Street
Corvallis, OR 97330
Tel: (541) 766-6750 Fax: (541) 766-3549
<http://extension.oregonstate.edu/benton/>

Clackamas County Extension
200 Warner-Milne Rd.
Oregon City, OR 97045
Tel: (503) 655-8631 Fax: (503) 655-8636
<http://extension.oregonstate.edu/clackamas/>

Lane County Extension
950 W 13th Avenue
Eugene, OR 97402-3913
Tel: (541) 682-4243 Fax: (541) 682-2377
<http://extension.oregonstate.edu/lane/>

Marion County Extension
3180 Center St NE Room 1361
Salem, OR 97301
Tel: (503) 588-5301 Fax: (503) 585-4940
<http://extension.oregonstate.edu/marion/>

Multnomah County Extension
211 SE 80th Avenue
Portland, OR 97251-1597
Tel: (503) 725-2000 Fax: (503) 725-2020
<http://extension.oregonstate.edu/multnomah/>

Polk County Extension
182 SW Academy, Suite 222
Dallas, OR 97338
Tel: (503) 623-8395 Fax: (503) 831-3059
<http://extension.oregonstate.edu/polk/>

Washington County Extension
18640 NW Walker Rd. #1400
Beaverton, OR 97006-8927
Tel: (503) 725-2300 Fax: (503) 725-2100
<http://extension.oregonstate.edu/washington/>

Oregon State University, *continued*

Linn County Extension
 4th and Lyons (PO Box 765)
 Albany, OR 97321
 Tel: (541) 967-3871 Fax: (541) 967-9169
<http://extension.oregonstate.edu/linn/>

Yamhill County Extension
 2050 Lafayette Avenue
 McMinnville, OR 97128-9333
 Tel: (503) 434-7517 Fax: (503) 472-3054
<http://extension.oregonstate.edu/yamhill/index.html>

FEDERAL AGENCIES

**U.S. Department of Agriculture
 U.S. Forest Service**

Pacific Northwest Region
 PO Box 3623, 333 SW First Avenue
 Portland, Oregon 97208-3623
 Tel. (503) 808-2971
www.fs.fed.us/r6/

Pacific Northwest Research Station
 333 SW First Avenue
 Portland, OR 97208
 Tel. (503) 808-2592
www.fs.fed.us/pnw/

Willamette National Forest Supervisor's Office
 Federal Building, 211 East 7th Avenue,
 P.O. Box 10607,
 Eugene, OR 97440
 Tel. (541) 225-6300 Fax (541)
www.fs.fed.us/r6/willamette/

Mt. Hood National Forest
 Forest Headquarters
 16400 Champion Way
 Sandy, OR 97055
 Tel. (503) 668-1700

Ranger DistrictsRanger Districts

Detroit Ranger District
 HC73, Box 320
 Mill City, OR 97360
 Tel. (503) 854-3366 Fax (503) 854-4239

Estacada Ranger Station
 595 NW Industrial Way
 Estacada, OR 97023
 Tel. (503) 630-6861

Blue River Service Center (formerly Blue River Ranger
 District)
 P.O. Box 199
 Blue River, OR 97413
 Tel. (541) 822-3317 Fax (541) 822-1255

Zigzag Ranger Station
 70220 E. Highway 26
 Zigzag, OR 97049
 Tel. (503) 622-3191 or (503) 668-1704

Middle Fork Ranger District
 46375 Highway 58
 Westfir, OR 97492
 Tel. (541) 782-2283 Fax (541) 782-5306

Sweet Home Ranger District
 3225 Highway 20
 Sweet Home, OR 97386
 Tel. (541) 367-5168 Fax (541) 367-5506

Natural Resource Conservation Service
Service Centers

Tangent Service Center
 33630 McFarland Rd.
 Tangent, OR 97389-9627
 Tel. (541) 967-5925 Fax (541) 928-9345

Oregon City Service Center
 256 Warner Milne Rd
 Oregon City, OR 97045-4044
 Tel. (503) 655-3144 Fax (503) 656-3143

Eugene Service Center
 1600 Valley River Dr. Ste 230
 Eugene, OR 97401-2129
 Tel. (541) 465-6443 Fax (541) 465-6483

Salem Service Center
 3867 Wolverine St NE
 Salem, OR 97305-4266
 Tel. (503) 399-5741 Fax (503) 399-5799

Portland Service Center
 2701 NW Vaughn St., Ste 450
 Portland, OR 97210-5398
 Tel. (503) 326-3941 Fax (503) 326-3942

Dallas Service Center
 580 Main St, Ste A
 DALLAS, OR 97338-1911
 Tel. (503) 623-2396 ext 105 Fax (503) 623-6335

Hillsboro Service Center
 1080 SW Baseline, Ste B2
 Hillsboro, OR 97123
 Tel. (503) 648-3174 Fax (503) 681-9772

McMinnville Service Center
 2200 SW 2nd St.
 McMinnville, OR 97128-5444
 Tel. (503) 472-1474 Fax (503) 472-2459

U.S. Department of Interior
U.S. Fish and Wildlife Service

Oregon Fish and Wildlife Office
 2600 S.E. 98th Ave.
 Portland, OR 97266
 Tel. (503) 231-6179, Fax (503) 231-6195
 Endangered Species: http://oregonfwo.fws.gov/EndSpp/EndSpp_home.html
 Land & Water Conservation: http://oregonfwo.fws.gov/HabCons/HC_home.html
 Habitat Restoration & Conservation: http://oregonfwo.fws.gov/FWRest/FWR_home.html
 Partners for Fish & Wildlife Grant Program: http://oregonfwo.fws.gov/FWRest/FWR_Partners/pffw.htm
 Other U.S. Fish & Wildlife Service Grants: <http://endangered.fws.gov/grants/index.html>

U.S. Army Corps of Engineers

U.S. Army Corps of Engineers
 P.O. Box 2946
 Robert Duncan Plaza
 333 S.W. First Avenue
 Portland, OR 97208-2946
 Tel. (503) 808-5150
www.nwp.usace.army.mil/
 Permits: www.nwp.usace.army.mil/op/g/

Appendix E: _____

Oregon Department of Forestry Offices in the Willamette Valley

COUNTIES COVERED	OFFICE ADDRESS	TELEPHONE AND FAX
Benton	24533 Alsea Hwy. Philomath, OR 97370	(541) 929-3266 (541) 276-0710
Benton Polk Yamhill	825 Oak Villa Road Dallas, OR 97338	(503) 623-8146 (503) 623-9034
Washington West Multnomah Yamhill	801 Gales Creek Road Forest Grove, OR 97116	(503) 357-2191 (503) 357-4548
Linn Marion	22965 N. Fork Road SE Lyons, OR 97358	(503) 859-2151 (503) 859-2158
Clackamas East Multnomah	14995 S. Hwy 211 Molalla, OR 97038	(503) 829-2216 (503) 829-4736
East Lane	3150 Main St. Springfield, OR 97478	(541) 726-3515 (541) 726-2505
Linn	4690 Hwy 20 Sweet Home, OR 97386	(541) 367-6108 (541) 367-5613

Appendix F:

Specialized Restoration Services and Supplies

<p>This list is not exhaustive. Contact your local Oregon Department of Fish and Wildlife, Natural Resource Conservation Service, U.S. Fish and Wildlife Service, U.S.D.A. Forest Service, and Oregon State University Extension Service, watershed council, or soil and water conservation district for additional servers and suppliers. <i>Note: Listing of these companies does not imply endorsement.</i></p>	<p>California Straw Works Phone/Fax (916) 453-1456 www.strawwattles.com</p> <p><i>Specialize in erosion control and revegetation with straw/fiber wattles.</i></p>
<p>ELWd Systems 1911 SW Campus Dr. # 655, Federal Way, WA 98023 (253) 838-4759, Fax (253) 815-9900 www.elwdsystems.com/BAER</p> <p><i>Specializes in FlowCheck® Structures for erosion barriers check dams, log dams, and low-grade stabilizers. Engineered log jams to provide and capture woody debris in streams and channels.</i></p>	<p>Fourth Corner Nurseries 3057 E. Bakerview Rd., Bellingham, WA 98226 (800) 416-8640, Fax (360) 592-4323 www.4th-corner-nurseries.com</p> <p><i>Offers habitat restoration plant kits described as "for homeowners in western Washington and Oregon who want to do their own habitat restoration work, but may not know which plants to use, or where to find these plants."</i></p>
<p>Integrated Resource Management, Inc. PO Box 547, Philomath, OR 97370 (541) 929-3408, Fax (541) 753-6920 www.integratedresourcemanagement.org</p> <p><i>A small forestry consulting company that specializes in restoring and maintaining oak on family woodlots. Specialize in low-impact selective tree removal.</i></p>	<p>Plants of the Wild PO Box 866, Tekoa, WA 99033 (509) 284-2848, Fax (509) 284-6464 www.plantsofthewild.com</p> <p><i>Besides native plants and seed, will do contract growing, offers native seed mixes for various habitats, seedling tree protection systems, and mulch mats.</i></p>
<p>Sunmark Seeds 845 NW Dunbar Ave. #101, Troutdale, OR 97060 (503) 241-7333, Fax (503) 491.0279 www.sunmarkseeds.com</p> <p><i>Native seed mixes.</i></p>	<p>Rainier Seeds, Inc. PO Box 1064, 1404 Fourth St., Davenport, WA 99122 (800) 828-8873, Fax (509) 725-7015 www.rainierseed.com, rainierseeds@rainierseeds.com</p> <p><i>Offers custom seed mixing, broadcast and drill seeding equipment, and biological mulches and erosion control blankets.</i></p>

Appendix G:

Permits Required to Collect Plants and Seeds for Regeneration, and Where to Get Them

STATE PERMITS

Oregon law (OAR Chapter 564) protects all wild plants in the state. With the exception of the species and genera listed below, which are completely protected, a permit from the Oregon Department of Agriculture is required to collect and remove plants from state owned public lands. Other than those listed below, plants may be collected from private property provided the landowner has issued a written and signed permit [OAR 564.020(2)].

TOTALLY PROTECTED WILDFLOWERS IN THE STATE OF OREGON	
All wild lilies of the genus <i>Lilium</i>	Native Rhododendrons or azaleas (genus <i>Douglasia</i>)
Mariposa tulip or butterfly lily (genus <i>Calochortus</i>)	Species of the genus <i>Kalmiopsis</i>
Mission bells or snake lily (genus <i>Fritillaria</i>)	Species of the genus <i>Pediocactus</i>
Adder's tongue, dog-tooth violet or avalanche lily (genus <i>Erythronium</i>)	Species of the genus <i>Coryphantha</i>
Lady's slipper (genus <i>Cypripedium</i>)	Species of the genus <i>Darlingtonia</i>
Purple lady's slipper (genus <i>Calypso</i>)	Species of the genus <i>Talinum</i>
Bitter root (genus <i>Lewisia</i>)	

Permits for collecting plants on Oregon public lands can be requested from the Oregon Department of Agriculture 635 Capitol St. NE, Salem, OR, 97301-2532, 503-986-4550.

FEDERAL PERMITS

Permits are required for collecting and removing plants or their seed from federally managed lands in Oregon. Plants on the Federal Threatened and Endangered List are completely protected and may not be collected or removed. A list of these species can be obtained from the U.S. Fish and Wildlife Service, Oregon Fish and Wildlife Office, 2600 S.E. 98th Avenue, Portland, Oregon 97266, 503-231-6179, FAX: 503-231-6195. To obtain collecting permits for lands administered by the U.S. Bureau of Land Management contact the nearest district office. District offices in the Willamette Valley are:

For permits to collect plants in a National Forest, contact the Ranger District responsible for administering the area from which you wish to collect, see Appendix D, Federal Agencies, U.S. Department of Agriculture, U.S. Forest Service, Ranger Districts.

SALEM DISTRICT 1717 Fabry Rd. SE Salem, Oregon 97306 503-375-5646 Fax 503-375-5622	EUGENE DISTRICT 2890 Chad Dr. PO Box 10226 Eugene, OR 97408 541-683-6600 Fax 541-683-6981
---	---

For permits to collect from other federally administered lands in the Willamette Valley, contact:

U.S. ARMY CORPS OF ENGINEERS 333 S.W. First Avenue Portland, OR 97204 P.O. Box 2946 Portland, OR 97208-2946 503-808-5150	U.S. FISH AND WILDLIFE SERVICE Willamette Valley NWR Complex 26208 Finley Refuge Rd. Corvallis, OR 97333-9533 541-757-7236
--	--

Appendix H: _____

Some Common and Special Status Wildlife Species and Habitats Where They Occur

SPECIES	HABITAT TYPE				
	Oak Woodland / Savanna	Grasslands	Marsh	Bottomland Hardwood Forest	Riparian Forest
Mammals ^{126, 127, 134}					
Fringed myotis bat (<i>Myotis thysanodes</i>)*	X	X			
Long-eared myotis bat (<i>Myotis evotis</i>)*	X			X	X
Western gray squirrel (<i>Sciurus griseus</i>)*	X				
Brush rabbit (<i>Sylvilagus bachmani</i>)	X	X		X	
White-tailed jackrabbit (<i>Lepus townsendii</i>)*		X			
Northern flying squirrel (<i>Glaucomys sabrinus</i>)	X			X	X
Camas pocket gopher (<i>Thomomys bulbivorus</i>)		X			
American beaver (<i>Castor canadensis</i>)				X	X
Deer mouse (<i>Peromyscus maniculatus</i>)	X	X		X	X
Townsend's vole or meadow vole (<i>Microtus townsendii</i>)		X			
Muskrat (<i>Ondatra zibethicus</i>)			X		
Grey fox (<i>Urocyon cinereoargenteus</i>)	X	X		X	X
Red fox (<i>Vulpes vulpes</i>)	X	X		X	X
Columbia black-tailed deer (<i>Odocoileus hemionus columbianus</i>)	X	X		X	X

* Oregon Sensitive Species ¹³¹

† Federal Threatened and Endangered List ¹³²

SPECIES	HABITAT TYPE				
	Oak Woodland / Savanna	Grasslands	Marsh	Bottomland Hardwood Forest	Riparian Forest
Birds ^{127, 128, 130, 132, 134} (names follow AOU checklist ¹³³)					
Great blue heron		X		X	X
Canada goose		X	X		
Wood duck				X	X
Mallard		X	X		
Bald eagle†*				X	X
Northern harrier	X	X			
Sharp-Shinned hawk	X			X	
Cooper's hawk	X			X	
Red-tailed hawk	X	X		X	
American kestrel	X	X			
Ring-neck pheasant	X	X			
Wild turkey	X			X	
California quail	X	X		X	X
Band-tailed pigeon	X				
Mourning dove	X	X			
Killdeer		X			
Great horned owl	X			X	
Northern pygmy owl*	X			X	
Rufous hummingbird	X			X	
Belted kingfisher			X		X
Acorn woodpecker*	X				
Northern flicker	X	X		X	X
Downy woodpecker	X			X	X
Hairy woodpecker	X			X	X
Streaked horn lark*		X			

SPECIES	HABITAT TYPE				
	Oak Woodland / Savanna	Grasslands	Marsh	Bottomland Hardwood Forest	Riparian Forest
Western wood-pewee	X	X		X	X
Willow flycatcher*					X
Western scrub-jay	X			X	
Horned lark*		X			
Tree swallow	X			X	X
Violet-green swallow	X			X	
Black-capped chickadee	X			X	X
White-breasted nuthatch*	X			X	
White-breasted nuthatch	X				
Brown creeper	X				
Marsh wren			X		
Western bluebird*		X			
American robin	X	X		X	X
Orange-crowned warbler	X			X	
Yellow warbler				X	X
Yellow-rumped warbler	X				
Common yellowthroat		X		X	X
Yellow-breasted chat*	X			X	X
Western tanager	X			X	
Spotted towhee	X			X	X
Chipping sparrow	X	X			
Oregon vesper sparrow*	X	X			
Savannah sparrow	X	X			
Song sparrow		X			X
White-crowned sparrow		X			
Dark-eyed junco	X				

SPECIES	HABITAT TYPE				
	Oak Woodland / Savanna	Grasslands	Marsh	Bottomland Hardwood Forest	Riparian Forest
Lazuli bunting		X			
Red-winged blackbird			X		
Western Meadowlark*		X			
Brown-headed cowbird	X			X	X
Bullock's oriole				X	X
Purple finch	X				
House finch	X			X	X
Pine siskin	X			X	
American goldfinch		X			
Reptiles ^{127, 129, 134}					
Painted turtle (<i>Chrysemys picta</i>)*			X		
Western pond turtle (<i>Clemmys marmorata</i>)*		X	X		
Northern alligator lizard (<i>Elgaria coerulea</i>)	X	X			
Western fence lizard (<i>Sceloporus occidentalis</i>)	X				
Northwestern garter snake (<i>Thamnophis ordinoides</i>)	X				
Common garter snake (<i>Thamnophis sirtalis</i>)	X	X	X	X	X
Gopher snake (<i>Pituophis catenifer</i>)	X	X		X	X
Racer (<i>Coluber constrictor</i>)	X				
Rubber boa (<i>Charina bottae</i>)	X	X			
Sharptail snake (<i>Contia tenuis</i>)*	X	X			
Garter snake (<i>Thamnophis spp.</i>)	X	X	X	X	X

SPECIES	HABITAT TYPE				
	Oak Woodland / Savanna	Grasslands	Marsh	Bottomland Hardwood Forest	Riparian Forest
Amphibians ^{127, 129, 134}					
Ensatina (<i>Ensatina eschscholtzi</i>)	X				
Long-toed salamander (<i>Ambystoma macrodactylum</i>)	X	X			
Northwestern salamander (<i>Ambystoma gracile</i>)	X	X			
Rough-skinned newt (<i>Taricha granulosa</i>)	X	X		X	
Pacific tree frog (<i>Hyla regilla</i>)	X	X	X	X	X
Bullfrog (<i>Rana catesbeiana</i>)		X	X		
Red-legged frog (<i>Rana aurora</i>)*		X	X		
Foothill yellow-legged frog (<i>Rana boylei</i>)*			X		
Fish (some species that would benefit from out of channel habitat restoration or enhancement) ¹³⁷					
Pacific lamprey (<i>Lampetra tridentata</i>)*					
Threespine stickleback (<i>Gasterosteus aculeatus</i>)					
White sturgeon (<i>Acipenser transmontanus</i>)					
Chinook salmon (<i>Oncorhynchus tshawytscha</i>)					
Cutthroat trout (<i>Oncorhynchus clarki</i>)					
Rainbow trout (<i>Oncorhynchus mykiss</i>)					
Steelhead (<i>Oncorhynchus mykiss</i>)					
Bull trout (<i>Salvelinus fontinalis</i>)†*					
Coho salmon (<i>Oncorhynchus kisutch</i>)†*					
Invertebrates ^{134, 135, 136}					
Fender's blue butterfly (<i>Icaricia icariodes fenderi</i>)†	X	X			
Anise swallowtail butterfly (<i>Papilio zelicaon</i>)	X	X			
Oregon giant earthworm (<i>Driloleirus macelfreshi</i>)†	?	?		?	?

Literature Cited

1. State of the Environment Report Science Panel 2000. Oregon State of the Environment Report 2000. Oregon Progress Board, Salem. 214 pp.
2. Defenders of Wildlife 1998. Oregon's Living Landscape. Defenders of Wildlife, Lake Oswego. 218 pp.
3. Oregon Plan for Salmon and Watersheds and Watershed Enhancement Board 2000. A guide to Oregon permits issued by state & federal agencies with a focus on permits for watershed restoration activities. State of Oregon, Salem. 38 pp.
4. Habbeck, J. 1961. The original vegetation of the mid-Willamette Valley, Oregon. *Northwest Science* 35(2):65-77.
5. Smith, J.E. 1949. Natural vegetation in the Willamette Valley, Oregon. *Science* 109:41-42.
6. Gumtow-Farrior, Daniel and Catherine Gumtow-Farrior 1994. Wildlife in white oaks woodlands. World forestry Center, Portland. 12 pp.
7. Larsen, E.M. and J.T. Morgan 1998. Management recommendations for Washington's priority habitats: Oregon white oak woodlands. Wash. Dept. Fish and Wildlife, Olympia. 37 pp.
8. Thilenius, J.F. 1968. The *Quercus garryana* forests of the Willamette Valley, Oregon. *Ecology* 49:1124-1133.
9. Agee, J.K. 1990. The historical role of fire in Pacific Northwest forests. In J.D. Walstad, S.R. Radosevich, and D.V. Sandberg (eds.) *Natural and prescribed fire in Pacific Northwest forests*. Oregon State University Press, Corvallis, OR. p. 25-38.
10. Dewberry, C. 1990. Burning issues: fire and the western Oregon landscape. Museum of Natural History, University of Oregon, Eugene. 11 pp.
11. McCreary, D.D. 2001. Regenerating rangeland oaks in California. University of California Agriculture and Natural Resources Publ. 21601. Oakland. 62 pp.
12. Lorimer, C.G. 1993. Cause of the oak regeneration problem. In, Loftis, D.L. and C.E. McGee (eds.). *Oak regeneration: serious problems, practical recommendations*. USDA, Forest Service. Gen. Tech. Rep. SE-84. p. 14-19.
13. Dey, D. 2002. The ecological basis for oak silviculture in eastern North America. In, McShea, W.J. and W.M. Healy (eds.). *Oak forest ecosystems; ecology and management for wildlife*. Johns Hopkins Univ. Press. Baltimore. p. 61-79.
14. Sprague, F.L. and H.P. Hansen 1946. Forest succession in the McDonald Forest, Willamette Valley, Oregon. *Northwest Science* 20:89-98.
15. Hastings, M.S., S. Barnhart, J.R. McBride 1997. Restoration management of northern oak woodlands. In, Pillsbury, N.H., J.

- Verner, W.D. Tietje (eds.). Proceedings symposium on oak woodlands: ecology, management, and urban interface issues. USDA, Forest Service. Gen. Tech. Rep. PSW-GTR-160. p. 275-280.
16. Reed, L.J. and N.G. Sugihara 1987. Northern oak woodlands-ecosystem in jeopardy or is it already too late? In, Plumb, T.R. and N.H. Pillsbury (tech. coords.), Proceedings symposium on multiple-use of California's hardwood resources. USDA, Forest Service Gen. Tech. Rep. PSW-100. p. 59-63.
 17. Sugihara, N.G. and L.J. Reed 1987. Prescribed fire for restoration and maintenance of Bald Hills woodlands. In, Plumb, T.R. and N.H. Pillsbury (tech. coords.), Proceedings symposium on multiple-use of California's hardwood resources. USDA, Forest Service Gen. Tech. Rep. PSW-100. p. 446-451.
 18. Johnson, P.S., S.R. Shifley, and R. Rogers 2002. The ecology and silviculture of oaks. CABI Publishing, New York. 503 pp.
 19. Oregon Dept. Fish & Wildlife 2000. Landowner's guide to creating grassland habitat for the Western Meadowlark and Oregon's other grassland birds. Oregon Dept. Fish & Wildlife, Portland. 16 pp.
 20. Titus, J.H., J.A. Christy, D. VanderSchaaf, J.S. Kagan, and E.R. Alverson 1996. Native wetland, riparian, and upland plant communities and their biota in the Willamette Valley, OR. Attachment F, Phase 1 Project: Inventory and Assessment Rep., Unpubl. Rep. Environmental Protection Agency. Seattle, WA. 49 pp.
 21. Bernhardt, E.A. and T.J. Swiecki 1997. Effects of cultural impacts on survival and growth of direct seeded and naturally occurring valley oak seedlings on hardwood rangeland. In, Pillsbury, N.H., J. Verner, W.D. Tietje (eds.). Proceedings symposium on oak woodlands: ecology, management, and urban interface issues. USDA, Forest Service. Gen. Tech. Rep. PSW-GTR-160. p. 301-311.
 22. Niemiec, S.S., G.R. Ahrens, S. Willits, and D.E. Hibbs 1995. Hardwoods of the Pacific Northwest. Oregon State Univ. Forest Research Laboratory Research Contribution 8. Corvallis. 115 pp.
 23. Silen, R.R. 1958. Silvical characteristics of Oregon white oak. USDA, Forest Service. Pacific Northwest Forest and Range Experiment Station Silvical Series No. 10. Portland. 13 pp.
 24. Hulse, D. (ed.) 1998. Willamette River Basin; a planning atlas. Institute for sustainable Environment. Eugene, OR. 72 pp.
 25. Bush, L. and R. Thompson 1990. Growing natives: planting oaks. *Fremontia*:105-107.
 26. Bonner, F.T. 1979. Fruit maturation in hardwoods. In, Proceedings seed collection workshop. USDA Forest Service Tech. Publ. SA-TP8. p. 6-10.
 27. Motz, R.W. 1997. Acorn collection, storage, sorting, and planting for the establishment of native oak without supplemental irrigation. In, Pillsbury, N.H., J. Verner, W.D. Tietje (eds.). Proceedings symposium on oak woodlands: ecology, management, and urban interface issues. USDA, Forest Service. Gen. Tech. Rep. PSW-GTR-160. p. 679-682.
 28. Adams, T. Jr., P.B. Sands, W.H. Weitkamp, and N.K. McDougald 1991. Blue and valley oak seedling establishment on California's hardwood rangelands. In, R.B. Standiford, (tech. coord.) Proceedings symposium on oak woodlands and hardwood rangeland management. USDA Forest Service Gen. Tech. Rep. PSW-126. p. 41-47.
 29. McCreary, D.D. and J. Tecklin 1997. Effects of seedling protectors and weed control on blue oak growth and survival. In, Pillsbury, N.H., J. Verner, W.D. Tietje (eds.). Proceedings symposium on oak woodlands: ecology, management, and urban interface issues. USDA, Forest Service. Gen. Tech. Rep. PSW-GTR-160. p. 243-250.
 30. Adams, T. Jr, P.B. Sand, W.H. Weitkamp, N.K. McDougald, and J.W. Bartolome 1987. Enemies of white oak regeneration in California. In, T.R. Plumb and N.H. Pillsbury (tech. coords.), Proceedings symposium on multiple-use of California's hardwood resources. USDA, Forest Service Gen. Tech. Rep. PSW-100. p. 459-462.

31. Tappeiner, J. and P.M. McDonald 1980. Preliminary recommendations for managing California black oak in the Sierra Nevada. In, T.R. Plumb (tech. coord.), Proceedings of the symposium on the ecology, management, and utilization of California oaks. USDA, Forest Service Gen. Tech. Rep. PSW-126. p.48-53.
32. McCreary, D.D. 1990. Field performance of valley oak seedlings under different irrigation regimes (abstract). In, van Sambeck, J.W. and M.M. Larson (eds.), Fourth workshop on seedling physiology and growth problems in oak planting. USDA, Forest Service Gen. Tech. Rep. NC-139. 21 pp.
33. Plum, T.R. and DeLasaux 1997. An evaluation of coast live oak regeneration techniques. In, Pillsbury, N.H., J. Verner, W.D. Tietje (eds.). Proceedings symposium on oak woodlands: ecology, management, and urban interface issues. USDA, Forest Service. Gen. Tech. Rep. PSW-GTR-160. p. 243-250.
34. Rose, R., C.E.C. Chachulski, and D. L. Haase 1998. Propagation of Pacific Northwest native plants. Oregon State University Press, Corvallis, OR. 248 pp.
35. Cowardin, L.M., V. Carter, F.C. Golet and E.T. LaRoe 1979. Classification of wetlands and deepwater habitats of the United States. USDI, Fish and Wildlife Service. FWS/OBS-79/31. 103 pp.
36. Kennedy, H.E. 1992. Artificial regeneration of bottomland oaks. In, Loftis, D.L. and C.E. McGee (eds.). Symposium, Oak regeneration: serious problems, practical recommendations. USDA, Forest Service Southeastern Forest Experiment Station Gen. Tech. Rep. SE-84. 319 pp.
37. National Research Council 1992. Restoration of aquatic ecosystems. National Academy Press, Washington, D.C. 576 pp.
38. Mannix, R. and J. Morlan 1994. Wetlands as varied as our region. World Forestry Center, Portland. 12 pp.
39. Keddy, P.A. 2000. Wetland ecology principles and conservation. Cambridge University Press. Cambridge, UK. 614 pp.
40. Zentner, J. 2001. Wetland enhancement, restoration, and creation. In, Kent, D.M. (ed.) Applied wetlands science and technology. Lewis Press. Boca Raton, FL. p. 133-279.
41. Kent, D.M. 2001. Designing Wetlands for Wildlife. In, Kent, D.M. (ed.). Applied wetlands science and technology. Second Addition. Lewis Publishers, Boca Raton, FL. 321 pp.
42. Stevens, M.L. and R. Vanbianchi 1993. Restorating wetlands in Washington. A guidebook for wetland restoration, planning, and implementation. Washington State Dept. of Ecology Publ. 93-17. 110 pp. plus Appendices.
43. Adamus, P.R. 2001. Guidebook for hydrogeomorphic (HGM)-based assessments of Oregon wetland and riparian sites: statewide classification and profiles. Oregon division of State Lands, Sale, OR. 162 pp.
44. Tennessee Department of Environment and conservation. Tennessee Erosion and sediment control handbook. www.state.tn.us/environment/wpc/sed_ero_controlhandbook.
45. U.S. Department of Agriculture, Natural Resource Conservation Service (SCS) 1994. Planning and design manual for the control of erosion, sediment, and stormwater. <http://abe.msstate.edu/csd/p-dm/index.html>.
46. U.S. Department of Agriculture, Soil Conservation Service 1982. Ponds - planning, design, and construction. Agriculture Handbook 590. 55 pp.
48. U.S. Army Corps of Engineers, Wetlands Research Program 1993. Hydraulic structures for wetlands. WRP Tech. Note HS-EM-3.1. U.S. Army Engineering Research & Development Center, Waterways Experiment Station, Vicksburg, MS. 6 pp.
49. U.S. Department of Agriculture, Natural Resource Conservation Service (SCS) 1992. Engineering field handbook. 210-EFH 1/92. Washington D.C.

50. Cronk, J.K. and M. Siobhon Fennesst 2001. Wetland plants, biology and ecology. Lewis Publishers, Boca Raton. 462 pp.
51. Newhouse, Bruce, Ecologist, Salix Association. Pres. Native Plant Society of Oregon. Personal Communications.
52. Harrington, C.A. and C. C. Kern 2002. Will Garry oak respond to release from overtopping conifers? In, Burton, P.J. (ed.). Garry oak ecosystem restoration: progress and prognosis. Proceedings 3rd annual meeting of the British Columbia Chptr. of the Society for Ecological Restoration. Univ. of Victoria. p. 39-46.
53. Anderson, C.W., T.M. Wood and J.L. Morace 1997. Distribution of dissolved pesticides and other water quality constituents in small streams, and their relation to land use, in the Willamette River Basin, Oregon. U.S. Geological Survey Water-Resources Investigations Rep. 97-4268. 87 pp.
54. Extonet 1996. Extension Toxicology Network Pesticide Information Profiles. Cooperative Extension Offices, Cornell University, Oregon State University, the University of Idaho, University of California at Davis and the Institute for Environmental Toxicology, Michigan State University. Files maintained and archived at Oregon State University, Corvallis.
55. U.S. Department of Agriculture, Natural Resource Conservation Service (SCS) 1991. Nutrient and sediment control system. Environmental Quality Tech. Note 4. 19 pp.
56. Oregon Dept. Fish & Wildlife 2001. Naturescaping. Oregon Dept. Fish and Wildlife, Portland. 204 pp.
57. Link, R. 2000. Landscaping for Wildlife in the Pacific Northwest. U of WA Press, Seattle. 320 pp.
58. Hoag, J.C. 2000. Harvesting, propagating, and planting wetland plants. USDA, Natural Resource Conservation Service Riparian/Wetland Project Information Series 14. 9 pp.
59. Hoag, J.C. 1994. Seed and live transplant collection procedures for 7 wetland plant species. USDA, Natural Resource Conservation Service Riparian/Wetland Project Information Series 6. 4 pp.
60. Stannard, M.S. and W. Crowder 2001. Biology, history, and suppression of reed canarygrass (*Phalaris arundinacea* L.). USDA, Natural Resource Conservation Service Tech Notes, Plant Materials 43. 8 pp.
61. Antieau, C.J. 2003. Biology and management of reed canarygrass, and implications for ecological restoration. Washington State Dept. Transportation Rpt. Seattle. 13 pp.
62. William, R.D., D. Ball, T.L. Miller, R. Parker, J.P. Yenish, T.W. Miller, D.W. Morishita and P.J.S. Hutchinson 2002. Pacific Northwest Weed Management Handbook. Oregon State University, Corvallis. 420 pp.
63. Whatcom County Noxious Weed Control Board, no date. Blackberries. <http://whatcom.wsu.edu/ag/homehort/weed/blackberries.htm>
64. Thompson, D.Q., R.L. Stuckey, and E.B. Thompson 1987. Spread, impact, and control of purple loosestrife (*Lythrum salicaria*) in North American wetlands. U.S. Fish and Wildlife Service. 55 pp. Jamestown, ND: Northern Prairie Wildlife Research Center Home Page. <http://www.npwrc.usgs.gov/resource/1999/loosstrf/loosstrf.htm>.
65. Remaley, T. 2002. Japanese knotweed. Plant Conservation Alliance, Alien Plant Working Group. 4 pp. <http://www.nps.gov/plants/alien/fact/pocu1.htm>.
66. Simon, B. 1998. Japanese knotweed. WA Noxious Weed Control Board. 2 pp. http://www.wa.gov/agr/weedboard/weed_info/jknotweed2.htm.
67. Parker, B., G. Miller, L.C. Burrill 1998. Scotch Broom. Oregon State University Extension Service, Washington State University Cooperative Extension, and University of Idaho Cooperative Extension System. Pacific Northwest Extension Pub. 103. 4 pp.

68. Prasad, R. 2002. Scotch broom (*Cytisus scoparius*) in British Columbia. Natural Resources Canada. <http://www.pfc.cfs.nrcan.gc.ca/biodiversity/broom%5Fe.html>.
69. Allen, J.A., B.D. Keeland, J.A. Stanturf, A.F. Clewell, and H.E. Kennedy, Jr. 2001. A guide to bottomland hardwood restoration. USDI, Geological Survey, Biological Resources Division Information and Technology Rep. USGS/BRD/ITR-2000-0011 and USDA, Forest Service, Southern Research Station Gen. Tech. Rep. SRS-40. 132 pp.
70. U.S. Fish and Wildlife Service 1998. A system for mapping riparian areas in the western United States. Washington D.C. ___ pp.
71. Dykaar, B.B. and P.J. Wigington, Jr. 2000. Floodplain formation and cottonwood colonization patterns on the Willamette River, Oregon, USA. *Environmental Manage.* 25(1):87-104.
72. Linn Soil & Water Conservation District, Natural Resources Conservation Service, South Santiam Watershed Council 1998. Guide for using Willamette Valley native plants along your stream. Publisher Unknown. 25 pp.
74. Guard, B.J. 1995. Wetland plants of Oregon & Washington. Lone Pine Publishing, Vancouver, B.C.
75. Jensen, E. C., W. R. Randall, R. F. Keniston, and D. N. Bever. 2000. Manual of Oregon Trees and Shrubs (7th edition). John Bell and Associates, Corvallis, OR. 305 pp.
75. Keniston, R.F. and W.R. Randall 1969. Manual of Oregon Trees and Shrubs. Oregon State University Book Stores, Inc., Corvallis. ___ pp.
76. Burns, R.M. and B.H. Honkala (Tech. Coords.) 1990. *Silvics of North America: 1. Conifers; 2. Hardwoods*. USDA, Forest Service Agriculture Handbook 654. 877 pp.
77. McKevlin, M.R. 1992. Guide to Regeneration of bottomland hardwoods. USDA, Forest Service. southeastern Forest Experiment Station Gen. Tech. Rpt. SE-76. 34 pp.
78. Gardner, P.A., R. Stevens, and F.P. Howe 1999. A handbook of riparian restoration and revegetation for the conservation of land birds in Utah with emphasis on habitat types in middle and lower elevations. Utah Division of Wildlife Resource Publ. 99-38. 48 pp
79. McAllister, L.S., K.A. Dwire, and S.M. Griffith 2000. Vegetation characterization of three contrasting riparian sites, Willamette Valley, Oregon. In, Wigington, P.J. Jr. and R.L. Beschta (eds.). *Riparian ecology and management in multi-land use watersheds*. American Water Resources Association, Middleburg, Virginia, TPS-00-2, 616 pp.
80. Allen, J.A., J. McCoy, and B.D. Keeland 1998. Natural establishment of woody species on abandoned agricultural fields in the lower Mississippi Valley: first- and second- year results. In, Waldrop, T.A. (ed.). *Proceedings of the ninth biannual southern silvicultural research conference*. USDA, Forest Service, Southern Research Station Gen. Tech. Rpt. SRS-20. ___ pp.
81. Read, R.A. 1958. Silvical characteristics of plains cottonwood. USDA, Forest Service. Rocky Mountain Forest and Range Experiment Station Paper No. 33. 18 pp.
82. Fried, J.S., J.C. Tappeiner, and D.E. Hibbs 1988. Bigleaf maple seedling establishment and early growth in Douglas-fir forest. *Canadian Journal of Forest Research* 18:1226-1233.
83. U.S. Department of Agriculture, Soil Conservation Service 1999. Restoration of woody plants within native range communities. Plant Materials Tech. Note MT-31. 6pp. <http://Plant-Materials.nrcs.usda.gov>.
84. Rainier Seeds, Inc. n.d. Seed catalog and reference guide. Rainier Seeds, Inc. Davenport, WA. 31 pp.

85. Ogle, D.G., J.C. Hoag, and J.D. Scianna 2000. Users guide to description, propagation and establishment of native shrubs and trees for riparian areas in the intermountain west. USDA NRCS TN Plant Materials No. 32. 22 pp.
86. Thomas, K. 2003. Invasive plant alert, false-brome. False-brome Working Group Rpt. Institute for Applied Ecology, Corvallis, OR. 2 pp.
87. Godwin, D. 1999. Life on the edge: Improving riparian function. Oregon State University Extension Service Publication EM 8738. Oregon State University, Corvallis. 7 pp.
88. Crowder, W. and W. Edelen 1996. Riparian Moisture zones - planting locations of woody and herbaecous species. USDA, NRCS Tech. Note Plant Materials 31. 3 pp.
89. Knopf, F.L., R.R. Johnson, T. Rich, F.B. Samson, and R.C. Szaro 1988. Conservation of riparian ecosystems in the United States. *Wilson Bull.* 100:272-284.
90. Naiman, R.J., K.L. Fetherston, S.J. McKay, and J. Chen 2001. Riparian Forests. In, Naiman, R.J. and R.E. Bilby (eds.). *River ecology and management, lessons from the Pacific coastal ecoregion.* Springer. New York. 705 pp.
91. Kelsey, K.A. and S.D. West 2001. Riparian wildlife. In, Naiman, R.J. and R.E. Bilby (eds.). *River ecology and management, lessons from the Pacific coastal ecoregion.* Springer. New York. 705 pp.
92. Gregory, S. and L. Ashkenas 1990. Riparian Management Guide, Willamette National Forest. USDA, Forest Service. Pacific Northwest Region Rpt. 120 pp.
93. Bilby, R.E. and P.A. Bisson 1998. Function and distribution of large woody debris. In, Naiman, R.J. and R.E. Bilby (eds.). *River ecology and management, lessons from the Pacific coastal ecoregion.* Springer. New York. 705 pp.
94. Flosi, G., S. Downie, J. Hopelain, M. Bird, R. Coey, and B. Collins 1998. California salmonid stream habitat restoration manual. California Dept. Fish and Game, Sacramento. 495 pp.
95. Federal Interagency Stream Restoration Working Group 2001. Stream corridor restoration, principles, processes, and practices. USDA, NRCS National Engineering Handbook part 653. 529 pp.
96. Franklin, J.F. and C.T. Dyrness 1988. Natural vegetation of Oregon and Washington. Oregon State University Press, Corvallis. 452 pp.
97. Pojar, J. and A. MacKinnon 1994. Plants of the Pacific Northwest coast. Lone Pine. Vancouver, B.C.. 572 pp.
98. Simpson, C., J. Koenig, J. Lippert, R. Love, B. Newhouse, N. Otting, S. Sundberg, D. Wagner, P. Warner 2002. Vascular plants of Lane County, Oregon; An annotated checklist. Emerald Chptr. Native Plant Society of Oregon, Eugene. 84 p.
99. Hitchcock, C.L. and A. Conquist 1973. Flora of the Pacific Northwest. Univ. Washington Press. Seattle. 730 pp.
100. Dechant, J.A., M.L. Sondreal, D.H. Johnson, L.D. Igl, C.M. Goldade, A.L. Zimmerman, and B.R. Euliss 2001. Effects of management practices on grassland birds: Western Meadowlark. USGS Northern Prairie Wildlife Research Center, Jamestown ND. 26 pp.
101. Packard, S. 1997. Restoration Options. In, Packard, S. and C. F. Mutel (eds.) *The tallgrass restoration handbook.* Society for Ecological Restoration. Island Press. Washington DC. 463 pp.
102. Boyd, R. 1986. Strategies of indian burning in the Willamette Valley. *Canadian Journal of Anthropology* 5:65-86.
103. Diboll, N. 1997. Designing seed mixes. In, Packard, S. and C. F. Mutel (eds.) *The tallgrass restoration handbook.* Society for Ecological Restoration. Island Press. Washington DC. 463 pp.

104. Clark, D. and M.V. Wilson 2001. Fire, mowing, and hand-removal of woody species in restoring a native wetland prairie in the Willamette Valley of Oregon. *Wetlands* 21:135-144.
105. Packard, S. and L.M. Ross 1997. Restoring Remnants. In, Packard, S. and C. F. Mutel (eds.) *The tallgrass restoration handbook*. Society for Ecological Restoration. Island Press. Washington DC. 463 pp.
106. Oregon Association of Nuserymen 2002. 2002-2003 directory and buyers guide. Wilsonville, OR. 372 pp.
107. Morgan, J.P. 1997. Plowing and seeding. In, Packard, S. and C. F. Mutel (eds.) *The tallgrass restoration handbook*. Society for Ecological Restoration. Island Press. Washington DC. 463 pp.
108. McClain, W.F. 1997. Prairie establishment and landscaping. Illinois Department of Natural Resources. Natural Heritage Tech. Publ. 2. 7 pp.
109. Payne, N.F. and F.C. Bryant 1994. Techniques for wildlife habitat management of uplands. McGraw-Hill, Inc. New York. 839 pp.
110. Parkard, S. and C.F. Mutel (eds.) 1997. *The tallgrass restoration handbook*. Society for Ecological Restoration. Island Press. Washington DC. 463 pp.
111. Sheley, R.L. and J.K. Petroff (eds.) 1999. *Biology and management of noxious rangeland weeds*. Oregon State University Press, Corvallis 438 pp.
112. Mullin, B. Purple loosestrife 1999. Sheley, R.L. and J.K. Petroff (eds.) *Biology and management of noxious rangeland weeds*. Oregon State University Press, Corvallis 438 pp.
113. O'Keefe, M.A. 1995. Frequent mowing may increase quality of prairie restoration. *Restoration and Management Notes* 13:109-110.
114. Riley, A.L. 1998. *Restoring streams in cities, a guide for planners, policymakers, and citizens*. Island Press, Washington D.C. 423 pp.
115. Clinebell, R.R. 1997. Tips for gathering individual species. In, Parkard, S. and C.F. Mutel (eds.). *The tallgrass restoration handbook*. Society for Ecological Restoration. Island Press. Washington DC. 463 pp.
116. Apfelbaum, S.I., B.J. Bader, F. Faessler, and D. Mahler 1997. Obtaining and processing seeds. In, Parkard, S. and C.F. Mutel (eds.). *The tallgrass restoration handbook*. Society for Ecological Restoration. Island Press. Washington DC. 463 pp.
117. Solecki, M.K. 1997. Controlling invasive plants. In, Parkard, S. and C.F. Mutel (eds.). *The tallgrass restoration handbook*. Society for Ecological Restoration. Island Press. Washington DC. 463 pp.
118. Oregon Department of Agriculture 2003. Noxious Weed Quarantine List. Oregon Administrative Rule 603-52-1200.
119. Ross, M.A. and C.A. Lembi 1999. *Applied weed science*. Prentice Hall. 452 pp.
120. Coombs, E.M., P.B. McEvoy, and C.E Turner 1997. Tansy ragwort. In, Sheley, R.L. and J.K. Petroff (eds.). *Biology and management of noxious rangeland weeds*. Oregon State University Press, Corvallis 438 pp.
121. Miller, H.C., D. Clausnitzer, and M.M. Borman 1999. Medusahead In, Sheley, R.L. and J.K. Petroff (eds.). *Biology and management of noxious rangeland weeds*. Oregon State University Press, Corvallis 438 pp.
122. Beck, K.G. 1999. Biennial thistles. In, Sheley, R.L. and J.K. Petroff (eds.). *Biology and management of noxious rangeland weeds*. Oregon State University Press, Corvallis 438 pp.

123. Morishita, D.W. 1999. Canada thistle. In, Sheley, R.L. and J.K. Petroff (eds.). *Biology and management of noxious range-land weeds*. Oregon State University Press, Corvallis 438 pp.
124. Roche, C. T. 2003. Meadow knapweed. Washington State University Cooperative Extension, Oregon State University Extension Service, and University of Idaho Cooperative Extension System. Pacific Northwest Extension publication 0566. 4 pp.
125. Gregory, S. , F.J. Swanson, W.A. McKee, and K.W. Cummins 1991. An ecosystem perspective of riparian zones: focus on links between land and water. *BioScience* 41:540-551. L. Ashkenas 1990. *Riparian Management Guide*, Willamette National Forest. USDA, Forest Service. Pacific Northwest Region Rpt. 120 pp.
126. Verts, B.J. and L.N. Carraway 1998. *Land mammals of Oregon*. University of Calif. Press. Berkely. 668 pp.
127. Marshall, D.B. 1996. *Species at Risk*. Oregon Dept. Fish and Wildlife. Portland, OR.
128. Marshall, D.B., M.G. Hunter and A.L. Contreras (eds.) 2003. *Birds of Oregon: a general reference*. Oregon State University Press. Covallis, OR 768 pp.
129. Vesely, D.G., J.C. Hagar and D.G. Chiller 1999. *Survey of Willamette Valley Oak Woodlan Herpetofauna, 1997-1998*. Pacific Wildlife Research. Corvallis, OR. 8pp.
130. Hagar, J.C. and M.A. Stern 2001. Avifauna in oak woodlands of the Willamette Valley, Oregon. *Northwestern Naturalist* 82:12-25.
131. State of Oregon 2001. *Oregon Administrative Rules, Chapter 635, Division 100-0040*.
132. U.S. Fish and Wildlife Service. http://ecos.fws.gov/tess_public/TESSWebpageRegionLists?lead_region=1#OR
133. American Ornithologist's Union 1998. *The A.O.U. Check-list of North American Birds*. Seventh edition. Buteo Books, Shipman, VA. 829 pp. (www.aou.org/aou/birdlist.html)
134. Johnson, D.H. and T.A. O'neil (managing directors) 2001. *Wildlife-habitat relationships in Oregon and Washington*. Oregon State Univ. Press. Corvallis. 735 pp.
135. Neil, W. 2001. *The guide to butterflies of Oregon ans Washington*. Westcliffe Publishers. Englewood, CO. 160 pp.
136. Pacific Biodiversity Institute. Endangered species information network. www.pacificbio.org/ESIN/OtherInvertebrates/OregonGiantEarthworm/GiantEarthworm.html
137. Oregon Department of Fish and Wildlife. South Willamette Watershed District Web site. www.dfw.state.or.us/springfield/fishspecies.html

About the Author

Bruce H. Campbell is a native Oregonian who spent his childhood on farms in Oregon and Idaho where he learned to love animals and the outdoors. His experiences while growing up taught him a deep understanding and appreciation for landowners and what it takes to make a living from farming.

Bruce holds two college degrees, one in biology and another in ecology. Over the course of his 27-year professional career, he has worked in Arizona, Alaska and Oregon. During his fifteen years in Alaska, Bruce studied and monitored the nesting ecology of the dusky Canada goose and its predators, including the Alaska brown bear. He has published over a dozen scientific articles on small mammals, dusky Canada geese, and habitat.

Bruce has worked for the Oregon Department of Fish and Wildlife for nine years and has a strong personal

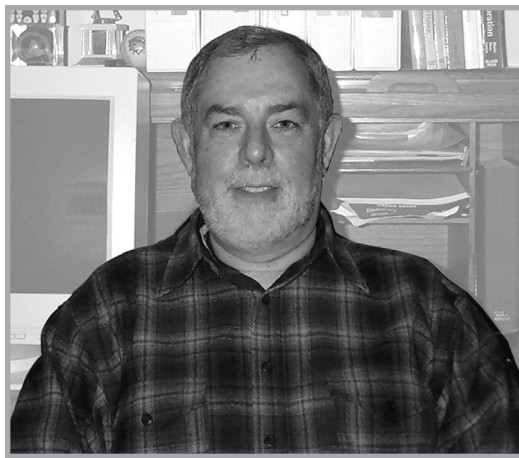

commitment to working with landowners to protect fish and wildlife habitat. His philosophy in working with landowners and habitat is reflected in a quote from one of his co-workers that he is fond of using: "I've never seen a piece of habitat I didn't like."

Bruce realized over the course of his career that protecting habitat on private property with rules and regulations doesn't work. He believes that the most effective way to gain landowner's cooperation in developing or protecting fish and wildlife habitat on their lands is to provide them with incentives. This is particularly true in the Willamette Valley where most of the land is in private ownership.

It is this belief, his understanding of agricultural life, and his experience over the past three years answering the question, "How do you do that?" that have led to the development of this guide.

